

SONY[®]

4-113-760-11(1)



LCD Digital Color TV



Operating Instructions

KDL-40XBR6
KDL-46XBR6
KDL-52XBR6

BRAVIA

XBR

Owner's Record

The model and serial numbers are located at the rear of the TV. Record these numbers in the spaces provided below. Refer to them whenever you call upon your Sony dealer regarding this TV.

Model Name

Serial No.

CAUTION

To prevent electric shock and blade exposure, do not use this polarized AC plug with an extension cord, receptacle or other outlet unless the blades can be fully inserted.

- Operate the TV only on 120 V AC.

Declaration of Conformity

Trade Name: SONY
 Model: KDL-40XBR6/KDL-46XBR6/
 KDL-52XBR6
 Responsible Party: Sony Electronics Inc.
 Address: 16530 Via Esprillo,
 San Diego, CA 92127 U.S.A.
 Telephone Number: 858-942-2230

This device complies with part 15 of the FCC rules. Operation is subject to the following two conditions: (1) This device may not cause harmful interference, and (2) this device must accept any interference received, including interference that may cause undesired operation.

NOTIFICATION

This equipment has been tested and found to comply with the limits for a Class B digital device, pursuant to Part 15 of the FCC Rules. These limits are designed to provide reasonable protection against harmful interference in a residential installation. This equipment generates, uses and can radiate radio frequency energy and, if not installed and used in accordance with the instructions, may cause harmful interference to radio communications.

However, there is no guarantee that interference will not occur in a particular installation. If this equipment does cause harmful interference to radio or television reception, which can be determined by turning the equipment off and on, the user is encouraged to try to correct the interference by one or more of the following measures:

- Reorient or relocate the receiving antenna.
- Increase the separation between the equipment and receiver.
- Connect the equipment into an outlet on a circuit different from that to which the receiver is connected.
- Consult the dealer or an experienced radio/TV technician for help.

Pursuant to FCC regulations, you are cautioned that any changes or modifications not expressly approved in this manual could void your authority to operate this equipment.

For Customers in Canada

This Class B digital apparatus complies with Canadian ICES-003.

CAUTION

Use the following Sony TVs only with the following WALL-MOUNT BRACKET or TV-stand.

Sony TV Model No.			
	KDL-40XBR6	KDL-46XBR6	KDL-52XBR6
Sony Wall-Mount Bracket Model No.	SU-WL500		
Sony TV Stand Model No.	WS-S10LS		
	SU-FL71M	-	

Use with other WALL-MOUNT BRACKETS or TV stands may cause instability and possibly result in injury.

To Customers

Sufficient expertise is required for installing the specified TV. Be sure to subcontract the installation to a Sony dealer or licensed contractor and pay adequate attention to safety during the installation.

Note

This television includes a QAM demodulator which should allow you to receive unscrambled digital cable television programming via subscription service to a cable service provider. Availability of digital cable television programming in your area depends on the type of programming and signal provided by your cable service provider.

Licensing Information

Macintosh is a trademark of Apple Inc., registered in the U.S. and other countries.

HDMI, the HDMI logo and High-Definition Multimedia Interface are trademarks or registered trademarks of HDMI Licensing, LLC.

Ferguson Patent Properties, LLC:
 U.S. Patent No. 5,717,422
 U.S. Patent No. 6,816,141

Manufactured under license from Dolby Laboratories. Dolby and the double-D symbol are trademarks of Dolby Laboratories.

In the United States, TV Guide and other related marks are registered marks of Gemstar-TV Guide International, Inc. and/or one of its affiliates. In Canada, TV Guide is a registered mark of Transcontinental Inc., and is used under license by Gemstar-TV Guide International, Inc.

The TV Guide On Screen system is manufactured under license from Gemstar-TV Guide International, Inc. and/or one of its affiliates.

The TV Guide On Screen system is protected by one or more of the following United States patents 4,908,713; 6,498,895; 6,850,693; 6,396,546; 5,940,073; 6,239,794 to Gemstar-TV Guide International, Inc. and/or its subsidiaries.

Gemstar-TV Guide International Inc. and/or its related affiliates are not in any way liable for the accuracy or availability of the program schedule information or other data in the TV Guide On Screen system and cannot guarantee service availability in your area. In no event shall Gemstar-TV Guide International, Inc. and/or its related affiliates be liable for any damages in connection with the accuracy or availability of the program schedule information or other data in the TV Guide On Screen system.

Blu-ray Disc is a trademark.

“BRAVIA” and BRAVIA, S-Force, MotionFlow, BRAVIA Sync, , DME⁺, MICRO VAULT, and “x.v. Color” are trademarks or registered marks of Sony Corporation.

“CrossMediaBar” is a trademark of Sony Corporation. “XMB” is a trademark of Sony Corporation and Sony Computer Entertainment Inc.

“PLAYSTATION” is a registered trademark and “PS3” is a trademark of Sony Computer Entertainment Inc.

Adobe is a registered trademark or a trademark of Adobe Systems Incorporated in United States and/or other countries.

DLNA[®], the DLNA Logo and DLNA CERTIFIED[™] are trademarks, service marks, or certification marks of the Digital Living Network Alliance.



For Customers in the United States

Lamp in this product contains mercury. Disposal of these materials may be regulated due to environmental considerations. For disposal or recycling information, please contact your local authorities or the Electronic Industries Alliance (www.eiae.org).

Contents

Welcome to the World of BRAVIA®

The Four Steps to a Full HD Experience: Set, Sound, Source, and Setup	4
Picture Quality and Aspect Ratio	4
TV Home Menu: XMB™ (XrossMediaBar)	5

Getting Started

1. Installing the TV	6
Carrying the TV	6
Preparation for Table-Top Stand	6
Preparation for Wall-Mount Bracket	7
When Installing the TV Against a Wall or Enclosed Area	7
Bundling the Connecting Cables	8
Securing the TV	9
2. Locating Inputs and Outputs	10
3. Connecting the TV	12
Cable System or VHF/UHF Antenna System	12
Cable System and VHF/UHF Antenna System	12
HD Cable Box/HD Satellite Box	12
PC	14
Other Equipment	15
4. Setting Up the Channel List – Initial Setup	16

Operating the TV

Inserting Batteries into the Remote Control ...	18
When Using the Remote Control	18
TV Controls	18
Remote Control Button Description	19
Indicators	24
Programming the Remote Control	25
Programming Other Equipment	25
Auto Backlight	25
Backlight Time Out	25
Reset the Remote Control	25
Manufacturer's Code List	26
Sony Equipment Codes	26
Other Manufacturer Equipment Codes	26
Using Other Equipment with Your Remote Control	27

Exploring Fun Features

Favorites	28
Displaying Favorites	28
Navigating Favorites	28
Adding to Favorites	28
Removing from Favorites	28



Quick Setup Guide (separate volume)
Provides a variety of optional equipment connection diagrams.

Background TV	29
Navigating Background TV	29
DLNA Certified™ Photo Media Player	29
Enjoying Photos and Music through USB Port	29
Using USB Equipment	29
Removing USB Equipment	29
USB Equipment Functionality	29
Photo	30
Accessing Photos	30
Navigating through Photo	30
Photo Options	31
Music	32
Accessing Music	32
Navigating through Music	33
Music Options	33
How to Use TV Guide On Screen	34
Using BRAVIA Sync with Control for HDMI ...	36
Using DIGITAL MEDIA PORT Adapter	36
Using P&P and PIP Features	37
To Enter P&P and PIP	37
To Change Inputs or Channels	37
To Exit from P&P and PIP	37

Using TV Settings

Media Category Icons	38
Adjusting TV Settings	38
Viewing Photos	38
Listening to Music	38
Watching TV	38
Accessing External Inputs	38
Navigating through TV Home Menu on XMB™	39
TV Settings Descriptions	40
Product Support	40
Clock/Timers Settings	40
Picture Settings	41
Sound Settings	43
Screen Settings	44
Channel Settings	46
Closed Captions (CC) Settings	47
Parental Lock Settings	47
External Inputs Settings	50
HDMI Settings	50
Network Settings	51
General Setup Settings	51
Initial Setup	52

Other Information

Troubleshooting	53
Specifications	57
Index	58



Customer Support

United States
<http://www.sony.com/tvsupport>

Canada
<http://www.sony.ca/support>

On-line Registration

United States
<http://productregistration.sony.com>

Canada
<http://www.sonystyle.ca/registration>

Welcome to the World of BRAVIA®

Thank you for purchasing this Sony BRAVIA® high-definition television. The quality of the image you see on your **BRAVIA** TV is only as good as the quality of the signal it receives. To experience the stunning detail of your new **BRAVIA** TV, you need access to HD programming. Your **BRAVIA** TV can receive and display HD programming from:

- Over-the-air broadcasting via HD-quality antenna
- HD cable subscription
- HD satellite subscription
- Blu-ray Disc™ player or other HD compatible external equipment

Contact your cable or satellite provider for information on upgrading to HD programming.

To learn more about HDTV, visit:

U.S.A. <http://www.sony.com/HDTV>

Canada <http://www.sonystyle.ca/hd>

The Four Steps to a Full HD Experience: Set, Sound, Source, and Setup

Along with your **BRAVIA** TV **set**, a complete HD system requires an HD **sound** system, a **source** of HD programming and proper **setup** connections. This manual explains basic setup connections (see page 12). The Quick Setup Guide, enclosed separately, illustrates how to connect other optional equipment.

Picture Quality and Aspect Ratio

You can enjoy crisp, clear images, smooth movement and high-impact visuals from 1080 HD signals. When you compare a high-definition signal to a standard analog signal, you will notice a big difference.

High-definition and standard-definition signals are transmitted with different aspect ratios (the width-to-height ratio of the image). HDTV uses a wider screen than conventional standard-definition TV.



16:9 (high-definition) source

Most HDTV signals use a wide screen aspect ratio of 16:9. The 16:9 fills your **BRAVIA** screen, maintaining a crisp, clear, vivid picture.

4:3 (standard-definition) source

Most standard-definition signals use a boxy 4:3 aspect ratio. When a 4:3 image is displayed on an HDTV, you will see black bars on the sides. The picture quality may not be as sharp as with HD sources.



- You can use the **Wide Mode** function of the TV to adjust the 4:3 image to fit the entire screen (see pages 21, 44 and 45).

TV Home Menu: XMB™ (XrossMediaBar)

The **XMB™** is an easy way to access the TV settings for customizing, making adjustments, viewing the available TV channels, photo and music files, and selecting connected equipment. Press the **HOME** button on your remote control to display the **XMB™**.

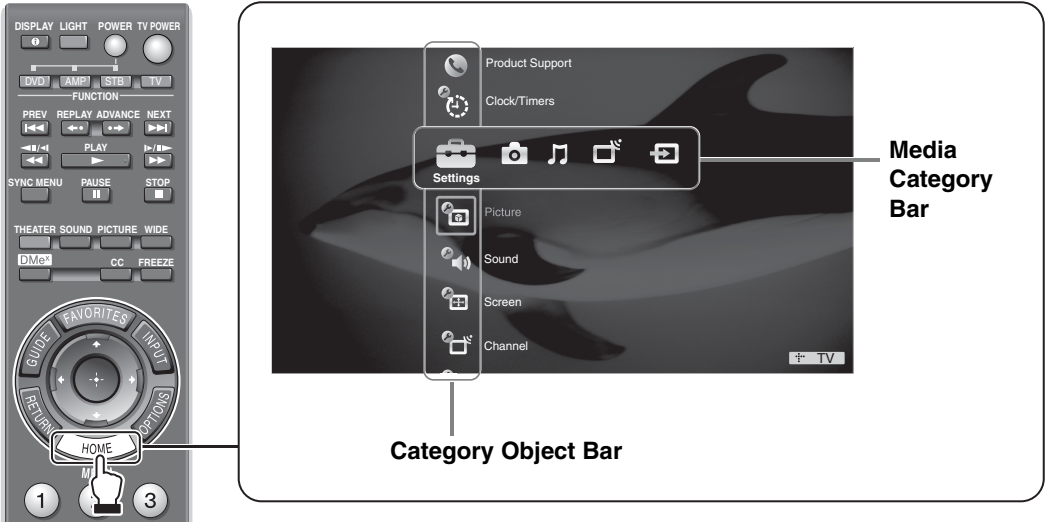

From the horizontal Media Category Bar you can control:

- **Settings:** adjust timer, picture, sound, screen and other options (see page 40 for customization options).
- **Photo:** view photo files via USB or compatible DLNA Certified™ equipment (see page 30).
- **Music:** listen to music files via USB or add music to a slideshow (see page 32).
- **TV Channels:** access TV Guide On Screen™ and available channels.
- **External Inputs:** select cable, satellite, VCR, DVD players or other optional equipment can also be selected from the vertical Category Object Bar from the **External Inputs**.

Your BRAVIA TV is Energy Star Compliant. It meets strict energy efficiency guidelines set by the EPA and US Department of Energy. ENERGY STAR is a joint program of these government agencies, designed to promote energy efficient products and practices.



- When the TV is initially set up, it is designed to stay within the Energy Star guidelines.
- Changes to certain features, settings, and functionalities of this TV (i.e. TV guide, Picture/Sound, Light Sensor, Power Savings) can slightly change the power consumption. Depending upon such changed settings, the power consumption may increase which possibly could exceed the limits required for the Energy Star qualification.



- This manual is for the 40, 46 and 52 inch **BRAVIA** KDL-XBR6 series models with screen size measured diagonally.

Getting Started

1. Installing the TV

This TV can be mounted on a wall using a Wall-Mount Bracket or placed on a TV stand (each sold separately). This section will explain:

- How to carry the TV
- Preparation for a Table-Top stand
- Preparation for a Wall-Mount Bracket
- Installation against a wall or enclosed area
- Bundling the connecting cables
- Securing the TV

Carrying the TV

Be sure to follow these guidelines to protect your property and avoid causing serious injury.

- Before carrying the TV, disconnect all cables.
- Carrying the large size TV requires two or more people.
- When carrying the TV, place your hand as illustrated and hold it securely. Do not subject the TV to shocks, vibration, or excessive force.

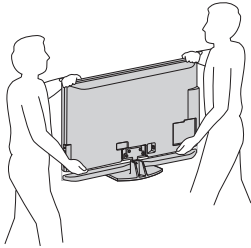

- Lift the TV by placing your palm directly underneath the panel but do not put stress on the LCD panel.

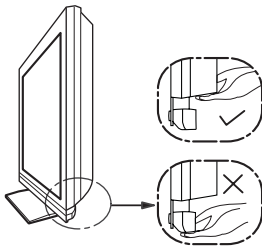

- Do not lift the TV from the bottom center.

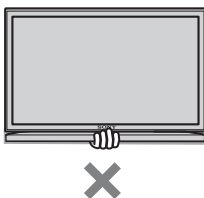

Preparation for Table-Top Stand

Follow the assembling steps required to place on a TV stand (except model, KDL-52XBR6).

- 1 Remove the Table-Top Stand and screws from the carton. The screws can be found in the accessory bag.

For product protection and safety reasons, Sony strongly recommends that you use the screws provided with the TV.

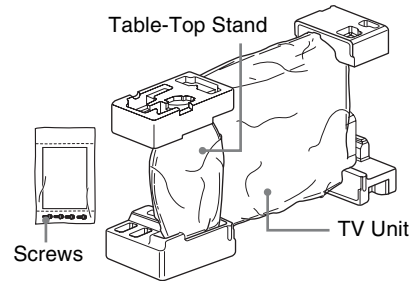

- 2 Place the Table-Top Stand on a level and stable surface.

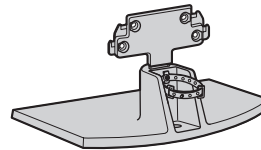

- 3 Gently slide the TV unit onto the neck of the Table-Top Stand and align the screw holes.

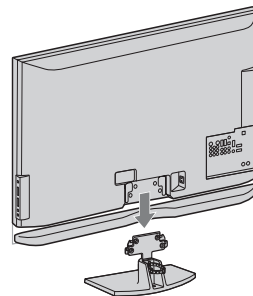

- Do not put stress on the LCD panel or the frame around the screen.
- Be careful to not pinch your hands or the AC power cord when you install the TV unit to the Table-Top Stand.

- 4 Use the supplied screws to attach the TV unit to the Table-Top Stand (refer to the “Attaching the Table-Top Stand” flyer).

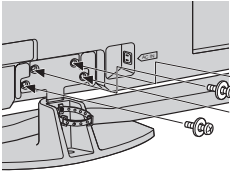

If an electric screwdriver is used, set the torque to tighten at approximately 1.5 N·m, 15 Kgf·cm.

Preparation for Wall-Mount Bracket

All models are ready to be mounted on a wall.

- For product protection and safety reasons, Sony strongly recommends that you use the Wall-Mount Bracket model designed for your TV and the wall-mounting of your TV should be performed by a Sony dealer or licensed contractor.
- Sufficient expertise is required in installing this TV, especially to determine the strength of the wall for withstanding the TV’s weight.
- Be sure to use the screws supplied with the Wall-Mount Bracket when attaching the mounting hooks to the TV set. The supplied M6 screws are designed so that they are 8 mm to 12 mm in length when measured from the attaching surface of the mounting hook. The diameter and length of the screws differ depending on the Wall-Mount Bracket model. Use of screws other than those supplied may result in internal damage to the TV set or cause it to fall, etc.

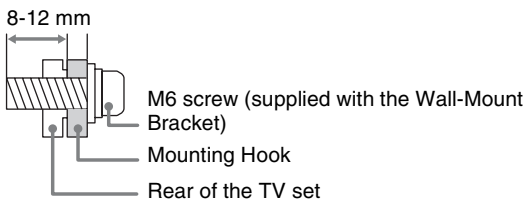

- Be sure to store the unused screws and Table-Top Stand in a safe place until you are ready to attach the Table-Top Stand. Keep the screws away from small children.

For details on how to use the Wall-Mount Bracket compatible with your model, visit www.sony.com/accessories
Or call 1-800-488-7669 (for United States)
1-877-899-7669 (for Canada)

When Installing the TV Against a Wall or Enclosed Area

Make sure that your TV has adequate air circulation. Allow enough space around the TV as shown below. Avoid operating the TV at temperatures below 41 °F (5 °C).

Installed with stand

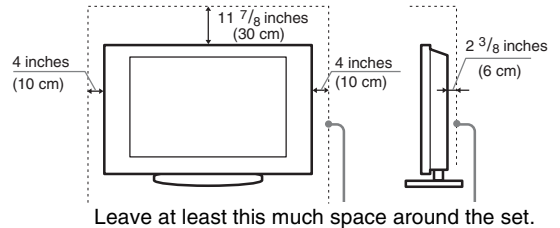

Installed on the wall

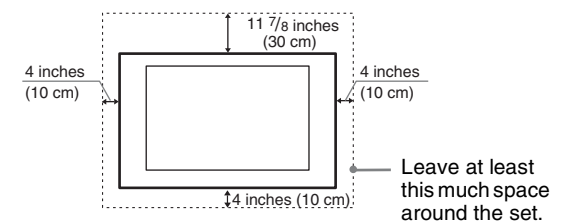

Never install the TV set as follows:

Air circulation is blocked.

Air circulation is blocked.

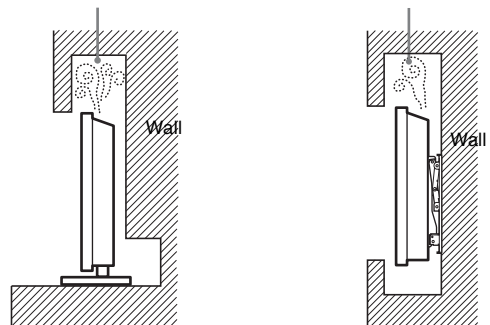

- Inadequate air circulation can lead to overheating of the TV and may cause damage to your TV or cause a fire.

Consider the following for best picture quality

- Do not expose the screen to direct illumination or sunlight.
- Use spot lighting directed down from the ceiling or cover the windows that face the screen with opaque drapery.
- Install the TV in a room where the floor and walls are not of a reflective material.

(Continued)

- When moving the TV from a cold area to a warm area, a sudden room temperature change may cause the TV's picture to blur or show poor color due to moisture condensation. Should this occur, please wait a few hours to allow the moisture to evaporate before powering on the TV.

Bundling the Connecting Cables

You can bundle the connecting cables as illustrated below.

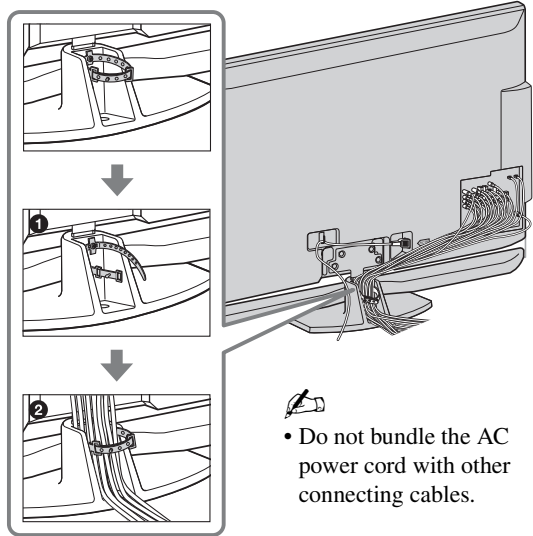

Securing the TV



Sony strongly recommends taking measures to prevent the TV from toppling over. Unsecured TVs may topple and result in property damage, serious bodily injury or even death.

Prevent the TV from Toppling Over

- Secure the TV to a wall and/or stand.
- Do not allow children to play or climb on furniture and TV sets.
- Avoid placing or hanging items on the TV.
- Never install the TV on:
 - slippery, unstable and/or uneven surfaces.
 - furniture that can easily be used as steps, such as a chest of drawers.
- Install the TV where it cannot be pulled, pushed, or knocked over.
- Route all AC power cords and connecting cables so that they are not accessible to curious children.

Use a Sony TV Stand

Use a Sony specified TV stand (see page 2) and follow the instruction manual provided with the Sony TV stand.

If a Sony specified TV stand is not used, consider the following recommended measures.

Recommended Measures to Secure the TV

Secure the Stand for the TV

Make sure the TV stand can adequately support the weight of the TV. Use two angle braces (not supplied) to secure the stand.

For each angle brace use the appropriate hardware to:

- attach one side of the angle brace to the wall stud.
- attach the other side to the TV stand.

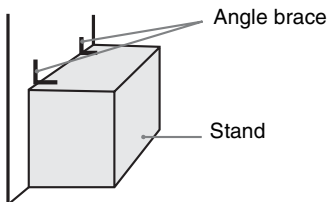

Secure the TV to the Stand

Use the optional hardware listed below (not supplied):

- M6 × 10-12 mm anchor bolt (screwed into the TV's Table-Top Stand)
- A screw or similar (attach it to the TV stand)

- Rope or chain (strong enough to support the weight of the TV). Make sure that there is no excess slack in the rope or chain.

An alternative way to secure the TV is with an optional Sony Support Belt Kit.

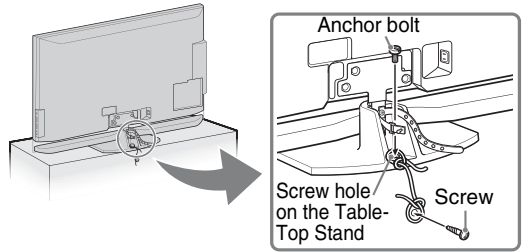

Contact Sony Customer Support to purchase the optional Support Belt Kit by providing your TV model name.

- For United States call: 1-800-488-7669 or visit: www.sony.com/accessories
- For Canada call: 1-877-899-7669

Anchor the TV to the Wall

Use the hardware listed below (not supplied):

- Two M6 × 10-12 mm anchor bolts (screw into the top-most wall-mount holes located on the rear of the TV)
- Rope or chain (attach to one M6 anchor bolt)
- Wall-anchor (attach to the wall stud) strong enough to support the weight of the TV (pass the rope through the wall-anchor, then attach to the other M6 anchor bolt)

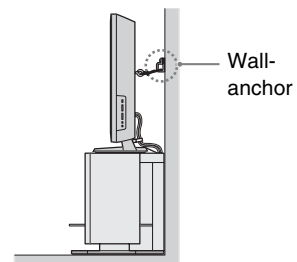
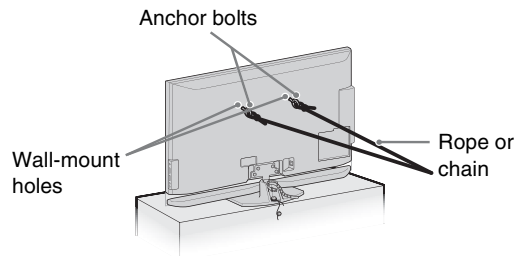

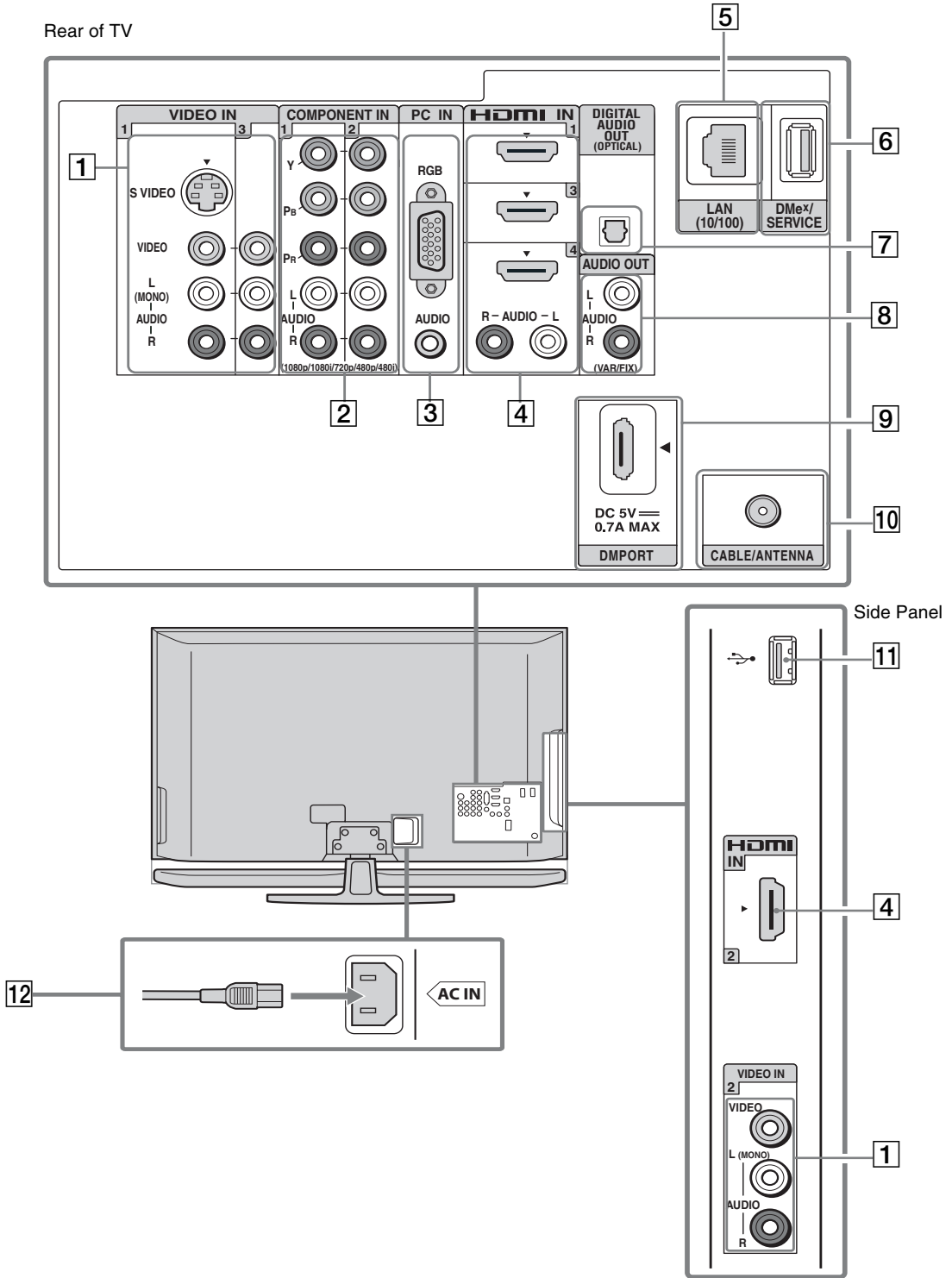

- Securing the TV to the stand without securing it and the stand to the wall provides minimum protection against the TV toppling over. For further protection, follow all three measures recommended above.

2. Locating Inputs and Outputs



- This TV displays all video input signals in a resolution of 1,920 dots × 1,080 lines.
- An HDMI or Component video (YPbPr) connection is required to view 480i, 480p, 720p, 1080i and 1080p video formats. 1080/24p is available only with HDMI connection.

Item	Description
1 VIDEO IN 1 S VIDEO	Connects to the S VIDEO output jack of video equipment. If both composite video and S VIDEO are connected, S VIDEO signal has priority.
VIDEO IN 2/3 VIDEO/L(MONO)-AUDIO-R	Connects to the composite video and audio output jacks on your A/V equipment.  • If you have mono equipment, connect its audio output jack to the TV's L (MONO) audio input jack.
2 COMPONENT IN 1/2 (1080p/1080i/720p/480p/480i)/L-AUDIO-R	Connects to your equipment's component video (YPbPr) and audio (L/R) jacks.
3 PC IN (RGB/AUDIO)	Connects to a personal computer's video and audio output connector (see page 14). Can also be connected to other analog RGB equipment. See "PC Input Signal Reference Chart" on page 14 for the signals that can be displayed.  • For some Apple Macintosh computers, it may be necessary to use an adapter (not supplied). If this is the case, connect the adapter to the computer before connecting the HD15-HD15 cable. • If the picture is noisy, flickering or not clear, adjust Phase and Pitch of Screen settings on page 45.
4 HDMI IN 1/2/3	HDMI (High-Definition Multimedia Interface) provides an uncompressed, all-digital audio/video interface between this TV and any HDMI-equipped A/V equipment. HDMI supports enhanced, or high-definition video, plus digital audio.
HDMI IN 4 R-AUDIO-L	If the equipment has a DVI jack and not an HDMI jack, connect the DVI jack to the HDMI IN 4 (with DVI-to-HDMI cable or adapter) jack, and connect the audio jack to the AUDIO IN (L/R) jacks of HDMI IN 4.  • Be sure to use only an HDMI cable that bears the HDMI logo. • When connecting a DVI-equipped PC to an HDMI jack, also connect an Audio cable between the PC and R-AUDIO-L jack.
5 LAN (10/100)	Connects to a Local Area Network using an Ethernet cable. You can use this connection to connect to a network, receive software updates and enjoy photos from the Internet (see page 30).
6 DMe ^x /SERVICE	This USB port is for service only unless you are connecting the optional BRAVIA external module (DMe ^x).
7 DIGITAL AUDIO OUT (OPTICAL)	Connects to the optical audio input of your digital audio equipment that is PCM/Dolby* Digital compatible.
8 AUDIO OUT (VAR/FIX)	Connects to the left and right audio input jacks of your analog audio equipment. You can use these outputs to listen to your TV's audio through your stereo system.
9 DMPORT	Connects to devices via a DIGITAL MEDIA PORT interface (not supplied) and displays photos or plays videos and music directly onto the TV from some DIGITAL MEDIA PORT equipment. Some devices can be controlled with the TV's remote control (see page 25).
10 CABLE/ANTENNA	RF input that connects to your cable or VHF/UHF antenna.
11 USB	Connects to USB equipment to access photo files and music files (see page 29).
12 AC IN	Connects to your power source. Connect the supplied power cord to AC IN and the nearest wall outlet.

* Manufactured under license from Dolby Laboratories. "Dolby" and the double-D symbol are trademarks of Dolby Laboratories.

3. Connecting the TV

Cable System or VHF/UHF Antenna System

You can enjoy high-definition and standard-definition digital programming (if available in your area) along with standard-definition analog programming.



- This TV is capable of receiving unscrambled digital programming for both cable (QAM and 8VSB) and external VHF/UHF antenna (ATSC).
- It is strongly recommended that you connect the CABLE/ANTENNA input using a 75-ohm coaxial cable to receive optimum picture quality. A 300-ohm twin lead cable can be easily affected by radio frequency interference, resulting in signal degradation.

Cable or VHF/UHF (or VHF only)

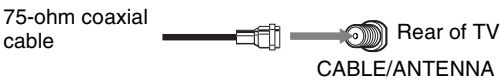

Cable System and VHF/UHF Antenna System

Use an optional A-B RF switch (not supplied) to switch between the cable and over-the-air antenna programming, as indicated below.

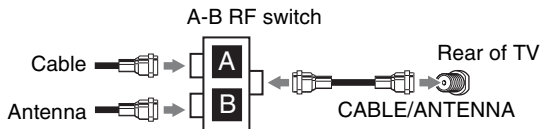

- Be sure to set the **Signal Type** setting to **Cable** or **Antenna** in the **Channel** settings for the type of input signal you choose (see page 46).

HD Cable Box/HD Satellite Box

You can enjoy high-definition programming by subscribing to a high-definition cable service or a high-definition satellite service. For the best possible picture, make sure you connect this equipment to your TV via the HDMI or component video (with audio) input on the back of your TV.

Shown with HDMI Connection

Rear of TV

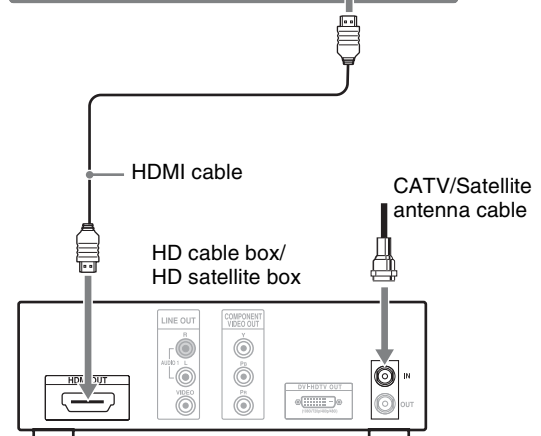
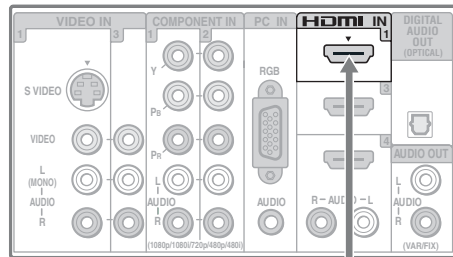

Shown with DVI Connection

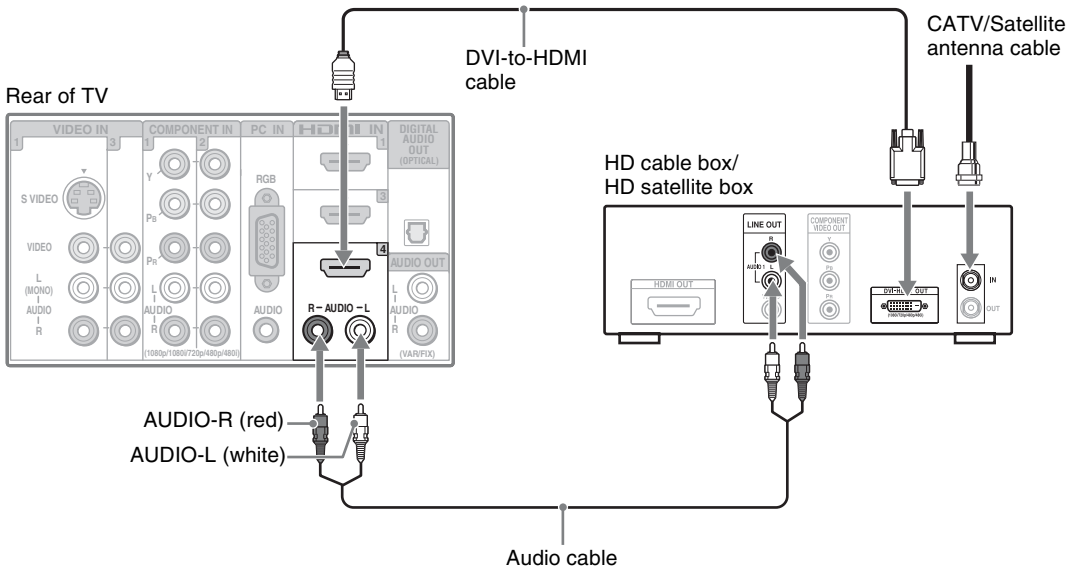

- If the equipment has a DVI jack and not an HDMI jack, connect the DVI jack to the HDMI IN 4 (with DVI-to-HDMI cable or adapter) jack and connect the audio jack to the AUDIO IN (L/R) jacks of HDMI IN 4. For details, see page 11.

Shown with Component Connection

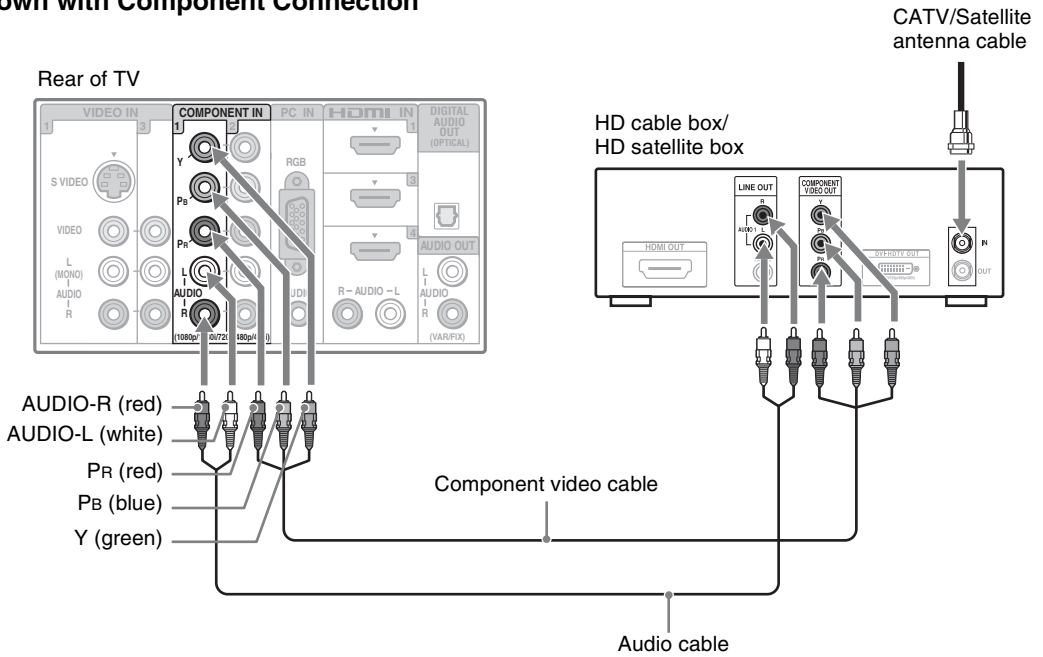

(Continued)

PC

Use the TV as a monitor for your PC by connecting a HD15-HD15 cable as shown below. This TV can also be connected to a PC with a DVI or HDMI output. (Refer to the separate Quick Setup Guide.)

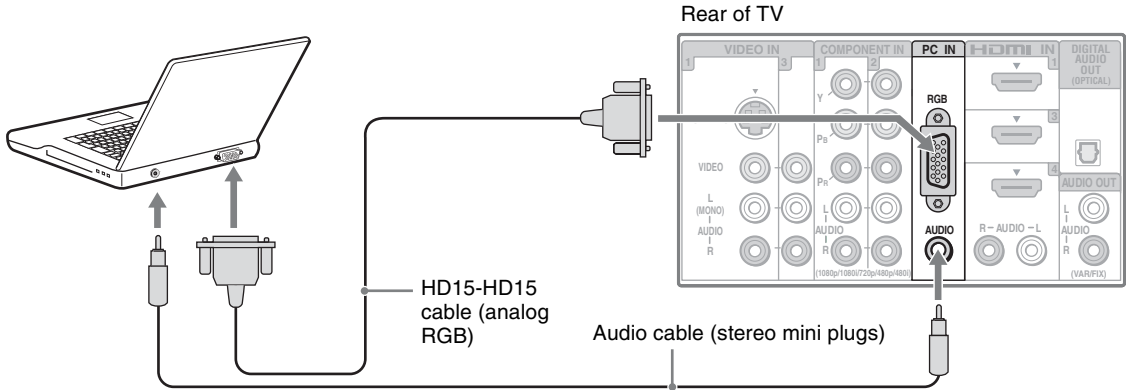

- Connect the PC IN jack to the PC using an HD15-HD15 cable with ferrite core (analog RGB) and audio cable (see page 11).
- If the PC is connected to the TV and no signal has been input from the PC for more than 30 seconds, the TV enters the standby mode automatically (see page 52).

PC Input Signal Reference Chart

After connecting the PC to the TV, set the output signal from the PC according to the supported resolutions and timings indicated below.

<i>Supported resolutions</i>				<i>Horizontal frequency (kHz)</i>	<i>Vertical frequency (Hz)</i>	<i>Standard</i>
<i>Signal</i>	<i>Horizontal (Pixel)</i>	<i>x</i>	<i>Vertical (Line)</i>			
VGA	640	x	480	31.5	60	VGA
	640	x	480	37.5	75	VESA
	720	x	400	31.5	70	VGA-T
SVGA	800	x	600	37.9	60	VESA Guidelines
	800	x	600	46.9	75	VESA
XGA	1,024	x	768	48.4	60	VESA Guidelines
	1,024	x	768	56.5	70	VESA
	1,024	x	768	60.0	75	VESA
WXGA	1,280	x	768	47.4	60	VESA
	1,280	x	768	47.8	60	VESA
	1,280	x	768	60.3	75	
	1,360	x	768	47.7	60	VESA
SXGA	1,280	x	1,024	64.0	60	VESA
HDTV	1,920	x	1,080	67.5	60	CEA-861*

- This TV's PC input does not support Sync on Green or Composite Sync.
- This TV's PC VGA input does not support interlaced signals.
- Your PC must support one of the above PC input signals to display on the television.
- For the best picture quality, it is recommended to use the signals (boldfaced) in the above chart with a 60 Hz vertical frequency. In plug and play, signals with a 60 Hz vertical frequency will be detected automatically. (PC reboot may be necessary.)

*The 1080p timing when applied to the HDMI input will be treated as a video timing and not PC timing. This affects **Picture** settings, **Wide Mode** settings, and **PIP** function. To view PC content set **Picture Mode** to **Custom**, **Wide Mode** to **Full**, and **Display Area** to **Full Pixel**.

Other Equipment

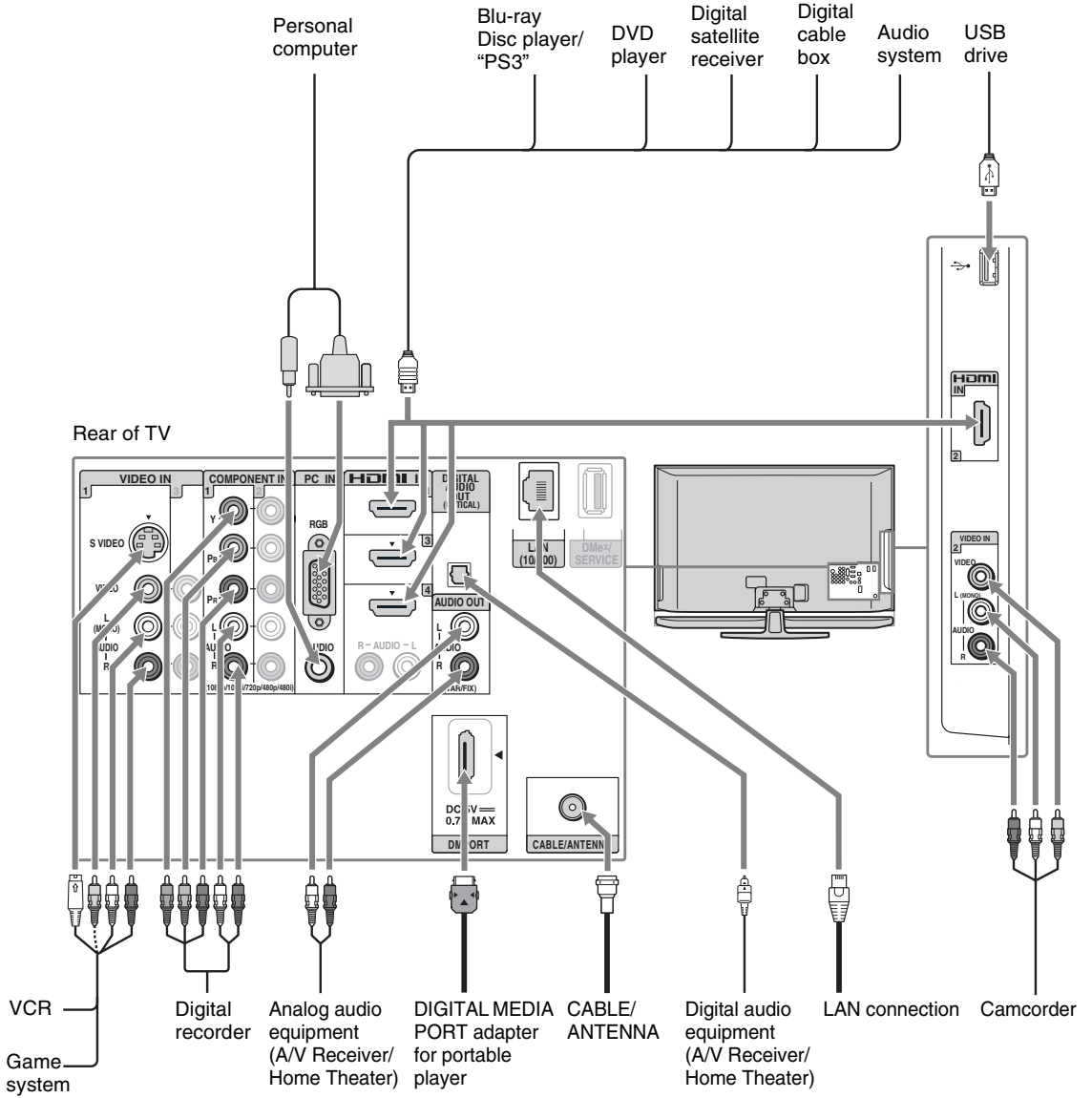

- Refer to the Quick Setup Guide (supplied) when connecting other equipment to your TV.

4. Setting Up the Channel List – Initial Setup

The **Initial Setup** screen appears when you turn on the TV for the first time.

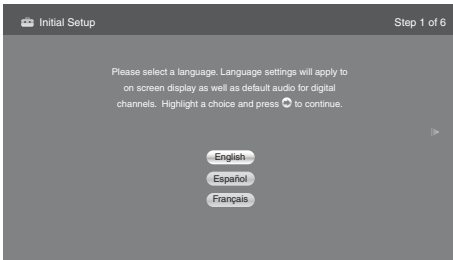

- 1 Complete your cable connections (refer to the preceding pages and the Quick Setup Guide provided separately) before proceeding with the **Initial Setup**.
- 2 Use the remote control to navigate through the **Initial Setup**:



↑/↓ button:
Allows you to highlight options where applicable.

⊕ button:
Allows you to select the highlighted option and advance to the next screen.

← button:
Allows you to move back to the previous screen.

→ button:
Allows you to move to the next screen.

- 3 Follow the help text provided on the screen to run **Auto Program**. **Auto Program** will scan for available channels from the signal source directly connected to the TV's CABLE/ANTENNA input.

If you receive channels from a cable box or satellite receiver without using the CABLE/ANTENNA input (e.g. using HDMI or component input), skip **Auto Program**.



- If you select **Skip**, you will be asked to disable **Channel Tuning Keys** to avoid accidental input change while using an external input; see page 50 for details.

- If the language that you have selected in the **Language** setting is available from the broadcaster as an **Alternate Audio** language, your TV will automatically switch to the matching language with the **Alternate Audio** feature. The **Alternate Audio** option may be accessed by pressing **OPTIONS** on the remote control when an alternate audio stream is available from the broadcaster. **Alternate Audio** is only available for digital programs (see page 44).

4 Set the date and time.

Begin your TV Guide On Screen Setup

When the **Initial Setup** is completed, the TV will display this screen and prompt you to set up the electronic program guide. Follow the on screen instructions using your remote control.

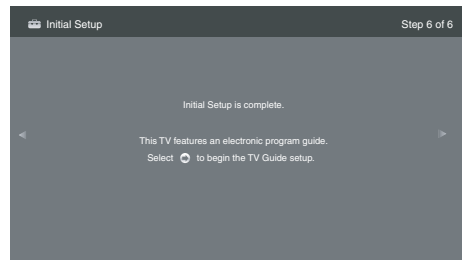

Next, you will see a confirmation screen with instructions on how to acquire the TV Guide On Screen service.

- The service is free of charge.
- Your TV acquires program listing information while your TV is turned off.
- Allow 24 hours (some areas may take longer) for the TV to fully receive the program listing information.
- Once the program information is obtained by the TV, you will be able to view a guide of up to two days of TV programming. See page 34 on how to use the TV Guide On Screen.

To Display TV Guide On Screen

Press **GUIDE**.



□ To Run Initial Setup Again or Auto Program at a Later Time

Select the **Initial Setup** feature from the **XMB™** or perform the steps described in the **Initial Setup** section on page 52. To run **Auto Program**, see page 46.

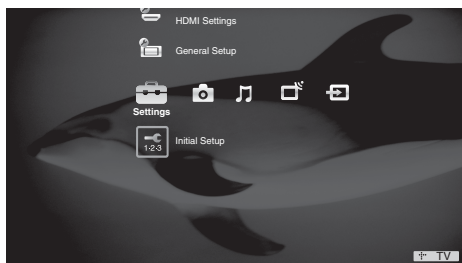

□ To Add Digital Channels

Use the **Add Digital Channels** feature as described on page 46. (Useful for antenna installations.)



- If you accidentally turn off the TV during the **Initial Setup** process, the **Initial Setup** will restart from the beginning when the TV is turned back on.
- **Auto Program** may be canceled while the channels are being scanned. Press **RETURN** first, then press either **◀/▶** on the remote control. Select **Yes** to cancel or **No** to resume **Auto Program**.

Operating the TV

Inserting Batteries into the Remote Control

Insert two size AA batteries (supplied) by matching **+** and **-** on the batteries to the diagram inside the battery compartment of the remote control.

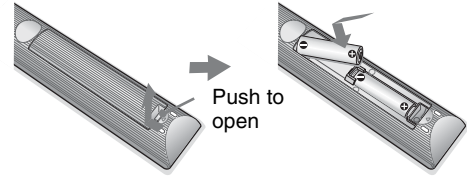

When Using the Remote Control

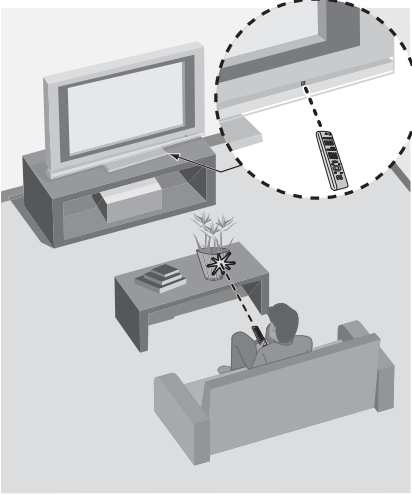

Follow the guidelines below

- Point your remote control directly at the IR sensor located on your TV.
- Make sure that no objects are blocking the path between the remote control and the IR sensor on your TV.
- Fluorescent lamps can interfere with your remote control; try turning off the fluorescent lamps.
- If you are having problems with the remote control, reinsert or replace your batteries and make sure that they are correctly inserted.

TV Controls

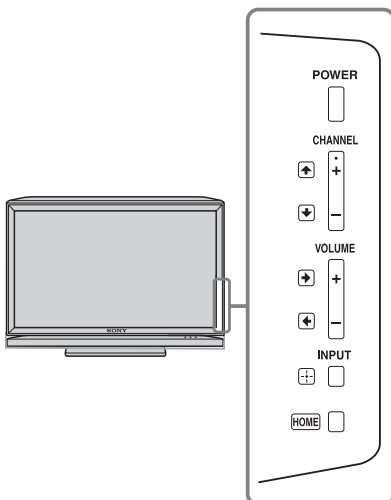

The buttons located on the side of the TV operate the same as the corresponding buttons on the remote control.

Remote Control Button Description



Button	Description
1 DISPLAY	Press once to display the banner with channel/program information you are watching. The banner will time out in about 10 seconds or press again to exit. You can select the banner size based on the amount of information. See Info Banner on page 51.
2 LIGHT	Press to light up the remote control buttons. The FUNCTION button indicator light will light up in red for the device mode the remote control is operating and other buttons will light up in blue (see page 25).
3 FUNCTION Buttons	The FUNCTION button indicator lights up momentarily when pressed to show which external equipment the remote control is operating. These buttons can be programmed to operate external equipment. You must first press one of these FUNCTION buttons to operate the corresponding equipment. See page 25 for "Programming the Remote Control".
4 Equipment Control/ BRAVIA Sync	The buttons listed below can operate video equipment programmed to the DVD, AMP, or STB FUNCTION buttons of the remote control. When the TV FUNCTION button is selected, the buttons can also be used to control the connected equipment with the Control for HDMI function (not available on all Control for HDMI equipment). ◀◀ PREV: Press to replay the current program from the previous chapter mark (if any) or from the beginning of the live TV cache. ◀◀ REPLAY: Press to replay the current program for a set period of time. ▶▶ ADVANCE: Press to advance forward a set period of time when playing back a recorded program. ▶▶ NEXT: Press to advance forward to the next chapter mark (if any) or to live TV when playing back a recorded program. ◀◀ (fast reverse): Press to play a program in fast rewind mode. ▶▶ PLAY: Press to play a program at a normal speed. ▶▶ (fast forward): Press to play a program in fast forward mode. ⏸ PAUSE: Press to pause playback. ■ STOP: Press to stop playback. SYNC MENU: Press once to display the Sync'd HDMI Devices (while a Control for HDMI device is not selected). Select the HDMI device and then press SYNC MENU to display the menu of connected equipment (not available on all Control for HDMI equipment). THEATER: Press to turn on and off the Theater Mode . The picture settings will be set for a cinema-like experience and the audio will be switched to the audio output of the attached speakers of your BRAVIA Sync audio system. Your BRAVIA Sync audio system must be connected by an HDMI connection to your TV (see page 36 for details).
5 SOUND	Press to cycle through different sound settings: Dynamic, Standard, Clear Voice . The sound modes can also be accessed in the Sound settings. For details, see Sound settings on page 43.
6 DMe^x	Press to access features in the optional BRAVIA external module (e.g. DMX-NV1). See your dealer or www.sony.com/bravia for more information. The module may not be available in all regions.



• The **5, PLAY** and **CH+** buttons have a tactile dot. Use them as a reference when operating the TV.

(Continued)

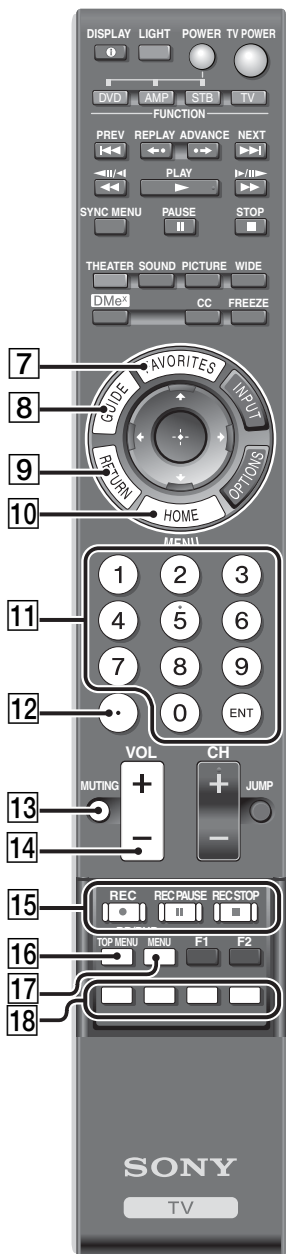

Button	Description
7 FAVORITES	Press once to display the Favorites menu. Press again to exit from the Favorites menu. See page 28 for detailed information.
8 GUIDE	Press to open the TV Guide On Screen system. Press again to exit the Guide. For instructions on using a specific menu, see “How to Use TV Guide On Screen” on page 34.
9 RETURN	Press to go back to the previous screen or exit from the screen when displaying menu items and settings.
10 HOME	Press to display the TV Home Menu/XMB™ to access the TV Home Menu items such as the TV Settings, Photo, Music, TV channels and External Inputs list (see pages 5 and 38).
11 0-9 ENT	Press 0-9 to select a channel; the channel changes after two seconds. Press ENT to change channels immediately.
12	Use with 0-9 and ENT to select digital channels. For example, to enter 2.1, press 2 , . , 1 and ENT .
13 MUTING	Press to mute the sound. Press again or press VOL + to restore the sound.
14 VOL +/-	Press to adjust the volume.
15 DVR/VCR Record Buttons	<ul style="list-style-type: none"> ● REC: Press to record. Pressing this button alone starts the recording process. ■ REC PAUSE: Press to pause recording. ■ REC STOP: Press to stop recording.
16 BD/DVD TOP MENU	Press to display the top menu of the BD/DVD disc.
17 BD/DVD MENU	Press to display the BD/DVD disc menu. <ul style="list-style-type: none"> • For more information, refer to the operating manual of the connected equipment.
18 Red, Green, Blue, Yellow	To use with Sony Blu-ray player (BD) see chart on page 26.

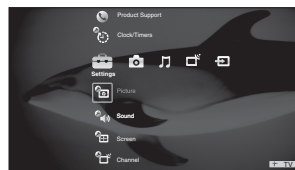



Button	Description
19 TV POWER	Press to turn on and off the TV.
20 POWER	Press to turn on and off the external equipment selected by FUNCTION buttons.

21 **WIDE** Press repeatedly to cycle through the available **Wide Mode** settings: **Wide Zoom**, **Normal**, **Full**, **H Stretch**, **Zoom**. The **Wide Mode** settings can be also accessed in the **Screen** settings (see pages 44 and 45).

Changing the Wide Screen Mode

4:3 Original source Standard-definition source	16:9 Original source High-definition source
Wide Zoom 	Wide Zoom
Normal 	Normal This mode is not available.
Full 	Full
H Stretch This mode is not available.	H Stretch
Zoom 	Zoom



- **Normal** is available with 480i or 480p sources only.
- **H Stretch** is only available with 720p, 1080i, 1080p and 1080/24p sources.

Changing the Wide Screen Mode for PC Timing

Incoming PC signal 800 × 600	Incoming PC signal 1,280 × 768
Normal 	Normal
Full 1 	Full 1
Full 2 	Full 2

(Continued)



Button	Description
--------	-------------

22 PICTURE	Press repeatedly to cycle through the available picture modes: Vivid, Standard, Cinema, Custom, Photo-Vivid, Photo-Standard, Photo-Original, Photo-Custom, Video, Text. (Available options depend on the current mode.) The picture modes can also be accessed in the Picture settings. For details, see Picture settings on page 41.
-------------------	--

23 FREEZE	Press once to display a frozen image with the current program in a window. Press again to fill the screen with the frozen image. Press a third time to return to the current program.
------------------	---



Press the **▲/▼/◀/▶** to move the small window showing current program to a different location on the screen.



- With the **Freeze** feature active, some features are unavailable.
- While the **Freeze** feature is active, pressing **HOME** will deactivate **Freeze** and display the **XMB™**.

24 CC	Press to cycle through the available settings for Closed Captions (CC): On, Off, and On with Muting.
--------------	---

25 INPUT	Press to display the list of External Inputs and TV mode. Press repeatedly to toggle through the inputs.
-----------------	---



- See page 50 on setting up the **External Inputs** labels.

26 ▲/▼/◀/▶ +	Press ▲/▼/◀/▶ to move focus/highlight. Press + to select/confirm an item.
------------------------	---

27 OPTIONS	Press to display a list of convenient functions and menu shortcuts. The OPTIONS menu items vary based on current input and content.
-------------------	--

Menu Item	Reference Page
Picture Adjustments	See page 41
Sound Adjustments	See page 43
P&P or PIP	See page 37
Exit P&P or Exit PIP	See page 37
Speakers	See page 44
Audio Swap	See page 37
Screen	See page 45
Add to Favorites/ Remove from Favorites	See page 28
MTS	See page 44
Alternate Audio	See page 44
Digital Rating	See page 48
Background TV	See page 29
Motion Enhancer	See page 42
Device Control	See page 50
Device Control (Menu) for DMPORT	See page 36
Photo	See page 30
Music	See page 32



- The **Digital Rating** and **Alternate Audio** options will appear in Options only when digital ratings or alternate audio streams are available in the currently tuned digital program.



Button	Description
28 JUMP	Press to jump back and forth between two channels. The TV alternates between the current channel and the last channel that was selected.
29 CH +/-	Press to scan through channels. To scan quickly through channels, press and hold down either +/-.
30 F1/F2	Press to select the function of connected components. For details, see "Using Other Equipment with Your Remote Control" on page 27.



Indicators

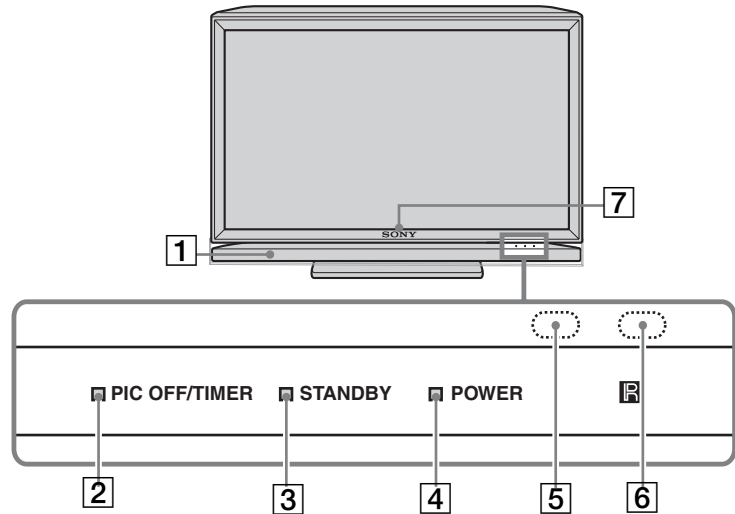

Item	Description
1 Speaker	Outputs the audio signal.
2 PIC OFF/TIMER LED	Lights up in green when the Picture Off feature is activated. Lights up in orange when the timer is set. When the timer is set, this LED will remain lit even if the TV is turned off. For details, see page 40 (Timer) and page 52 (Picture Off).
3 STANDBY LED	Lights up in red when your TV is in PC standby mode. If the LED blinks in red continuously, this may indicate that the TV needs servicing (see contacting Sony information on the back cover).
4 POWER LED	Lights up in green when the TV is turned on.
5 Light Sensor	Senses room light level and adjusts the screen brightness accordingly (see page 52 for details). Do not put anything near the sensor or the nearby general area (as shown above), as its function may be affected.
6 (IR) Infrared Receiver	Receives IR signals from the remote control. Do not put anything near the sensor, as its function may be affected.
7 SONY Logo	The Sony logo will illuminate when the TV is powered on. You can turn off the logo illumination, for details see page 52.

Programming the Remote Control

The remote control can be programmed to operate other equipment and is pre-programmed to operate the following Sony equipment.

Function Button	Sony Equipment	Code Number
DVD	DVD Player	31033
AMP	Receiver	52172
STB	Digital Satellite	01639

Programming Other Equipment

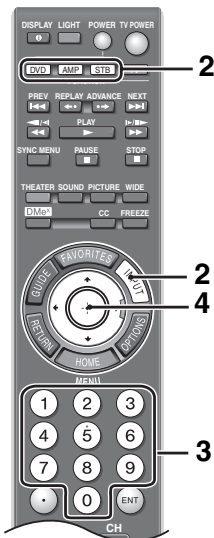

Follow the steps below to program your TV remote control.

- 1 Find the code that corresponds to your equipment from page 26. If more than one code is provided, try programming the first code listed.
- 2 Press and hold **DVD**, **AMP** or **STB** simultaneously with the **INPUT** button and release. When in the programming mode, the **FUNCTION** button blinks for approximately 30 seconds until a code is entered.
- 3 Enter the five digit code using **0-9** while the **FUNCTION** button is lit. If the code is not entered within 30 seconds, you must repeat step 2.
- 4 Press \oplus or **ENT** to confirm the code. If successfully programmed, the **FUNCTION** button blinks twice; if not, it blinks five times.



- Any of the **FUNCTION** buttons can be programmed to operate other equipment regardless of the labeling. For example, **DVD** can be programmed to operate a Blu-ray player.

Confirm the Programming

If you can turn your equipment on and off using the green **POWER** button, the programming is complete. If not, try the next code listed.



- In some cases, you may not be able to program your remote control. If this is the case, use your equipment's own remote control.

Auto Backlight

The backlight can be set to light up when a button is pressed.

To set backlight:

Press **LIGHT** and **MUTING** simultaneously until the four **FUNCTION** buttons blink red.

To turn off backlight:

Press **LIGHT** and **MUTING** until the **TV** button blinks red.

Backlight Time Out

The remote control can be set to remain lit longer than the default time setting of approximately five seconds with the **FUNCTION** buttons.

To change backlight time setting:

- 1 Press **LIGHT**, **VOL+**, and then **CH+** simultaneously until the **FUNCTION** button blinks red.
- 2 Select the **FUNCTION** button that corresponds to your preferred time out setting and press \oplus .

DVD	5 seconds (default)	AMP	10 seconds
STB	15 seconds	TV	20 seconds

Reset the Remote Control

To reset the remote control to the factory default settings, press **SOUND**, **TV POWER**, and then \oplus . The **FUNCTION** buttons blink red simultaneously when successfully reset.

Manufacturer's Code List

If your equipment's code is not listed, visit <http://esupport.sony.com/remotecodes> for a more comprehensive list.

Sony Equipment Codes

Sony Equipment	Programmable Code Number
AV Receiver	52172
Blu-ray Disc Player	41516, 42178, 42180
Cable-Digital	02177
DVD AV System	51622, 51558, 51658, 51858
DVD Changers	31633
DVD Player	31033, 31069, 31070
DVD/HDD Combo Player	31033, 31069, 31070
DVD/VCR Combo Player	30864
DVR/HDD Player	22181, 22182, 22183
Satellite	01639
VCR	21232, 21546, 22184

Other Manufacturer Equipment Codes

HD Blu-ray Players

Manufacturer	Code
LG	40741
Panasonic	41641
Philips	42084
Pioneer	40142
Samsung	40199

DVD Player

Manufacturer	Code
Coby	30778, 30852, 31077, 31086, 31107, 31165, 31177, 31351, 31628
Cyberhome	30816, 30874, 31023, 31024, 31117, 31129, 31502, 31537
GPX	30699, 30769
JVC	30558, 30623, 30867, 31164, 31550, 31602
Koss	30651, 30769, 30896, 31061, 31423
Memorex	30695, 30831, 31270
Panasonic	30490, 30503, 30571, 30703, 31762
Philips	30503, 30539, 30646, 30675, 31267, 31354, 32056
RCA	30522, 30571, 30717, 30790, 30822, 31022
Samsung	30490, 30573, 30744, 31044, 31075, 31470
Sylvania	30675, 31268
Toshiba	30503, 30539, 30573, 30695, 31154, 31503, 31588, 31608, 31854

DVD Changers

Manufacturer	Code
Sylvania	30675
Techwood	30692
Toshiba	30503, 31154
Yamaha	30497, 30545
Zenith	30741

DVD Recorder

Manufacturer	Code
Cyberhome	31129, 31502
JVC	31164
LG	30741
Lite-On	31158, 31416, 31440
Panasonic	30490
Philips	30646
Samsung	30490, 31470
Sylvania	30675
Toshiba	31588

DVD/VCR Combo Units

Manufacturer	Code
JVC	30867, 31164, 31550, 31602
Broksonic	30695, 31419
Panasonic	31762
Toshiba	30503, 31854
Zenith	30741, 30869

VCR's

Manufacturer	Code
Daewoo	20037, 20045, 20046, 20278, 21137
JVC	20041, 20067, 21162
Panasonic	20000, 20035, 20162, 20225, 20226, 20614, 20616, 21062, 21162, 21262
Philips	20000, 20035, 20045, 20048, 20081, 20162, 20209, 20616, 20618, 20739, 21081, 21181
Sylvania	20000, 20035, 20043, 20081, 20593, 21593

A/V Receiver/Home Theater Systems

Manufacturer	Code
Audiovox	30790, 51390
Bose	50674, 51229, 51933
Denon	50121, 51142, 51306, 51360, 52857
Emerson	50531
JVC	50331, 51495
Koss	30651
LG	51293
Onkyo	51298, 51320, 51805
Panasonic	50308, 51288, 51308, 51316, 51548, 51633, 51763, 51764
Philips	31267, 51189, 51266, 51269
Pioneer	50150, 50531, 50630, 50823, 51023, 51384
RCA	30790, 50531, 50823, 51023, 51254, 51390, 51511, 51609
Samsung	51295, 51500
Sherwood	31077, 51077, 51517, 51653
Yamaha	30497, 50176, 50354, 51023, 51276, 51331, 51376, 51815
Zenith	51293

Digital Video Recorders

Manufacturer	Code
TiVo	01442, 01443, 01444, 20618, 20636, 20739

Satellite

Manufacturer	Code
DirecTV	00099, 00247, 00392, 00566, 00639, 00749, 00819, 01076, 01108, 01109, 01142, 01377, 01392, 01414, 01442, 01442, 01443, 01444, 01609, 01639, 01640, 01749, 01856, 20739
Dish Network System	00775, 01170, 01505, 01775
EchoStar	00775, 01170, 01505, 01775
Funai	01377
GE	00392, 00566
Hitachi	00749, 00819, 01250
Hughes	00749, 01142, 01443, 01444, 01749, 20739
Humax	01790, 20739, 21797, 21988
JVC	00775, 01170, 01775
LG	01226, 01414, 22010
Panasonic	00247, 00701, 20614, 20616
Philips	00099, 00722, 00749, 00775, 00819, 01076, 01142, 01749, 20618, 20739
RCA	00143, 00392, 00566, 00775, 00855, 01142, 01392, 01442, 20880
Samsung	01108, 01109, 01142, 01276, 01377, 01442, 01609, 20739
TiVo	01442, 01443, 01444, 20618, 20636, 20739

Cable Box

Manufacturer	Code
Jerrold/General Inst./Motorola	00003, 00276, 00476, 00810, 01187, 01254, 01376
Pace	00008, 00237, 00877, 01877
Panasonic	00000, 00008, 00107, 00144
Pioneer	00144, 00533, 00877, 01877
Scientific Atlanta	00000, 00003, 00008, 00237, 00477, 00877, 01877
Zenith	00000, 00525, 00899

Using Other Equipment with Your Remote Control

Remote control tips are provided below for the equipment you have programmed on the **DVD, AMP, STB** buttons of the remote control. See page 25 for programming equipment to the remote control. Press **INPUT** to see your connected equipment in the **External Inputs** menu. Button functionality may differ depending on your equipment.

Button	Action	Universal Blu-ray, HD-DVD, DVD, DVD-R, DVD/HDD, DVD/VCR	Universal VCR, DVR	Universal SAT/CBL	Universal AMP/Receiver
Access Control					
DISPLAY	Display	✓	Information	✓	✓
⊕	Select	✓	✓	✓	✓
⊖	Clear, (cancel)	✓	✓	N/A	✓
ENT	Enter	✓	✓	✓	✓
Shortcuts Control					
GUIDE	Guide	✓	✓	✓	✓
FAVORITES	Favorites	N/A	N/A	✓	N/A
INPUT	Input Select	✓	✓	✓	✓
RETURN	Exit	✓	✓	✓	✓
HOME	Setup Menu	✓	✓	✓	✓
OPTIONS	Options	N/A	List	List	List
TOP MENU	Top Menu/List	Top Menu	List	List	Top Menu
MENU	Menu	Menu	Menu	Menu	Menu
F1	For selecting between DVD/VCR in combo units	HDD, DVD/HDD, DVD/VCR	VCR, VCR/DVD	N/A	N/A
F2		DVD	DVD	N/A	N/A
Equipment Control					
POWER	Turn on/off	✓	✓	✓	✓
⏮	Previous, Skip backward	✓	✓	✓	✓
⏪	Replay	✓	✓	✓	Band
⏩	Advance, Skip	✓	✓	✓	Surround
⏭	Next, Skip forward	✓	✓	✓	✓
⏮	Rewind	✓	✓	✓	✓
▶	Play	✓	✓	✓	✓
⏭	Fast Forward	✓	✓	✓	✓
⏸	Pause	✓	✓	✓	✓
■	Stop	✓	✓	✓	✓
Recording Control					
●	Record	✓	✓	✓	✓
⏸	Record Pause	✓	✓	✓	✓
■	Stop	✓	✓	✓	✓
Navigation Control					
⬆/⬇	Cursor up/down	✓	✓	✓	✓
⬅/➡	Cursor left/right	✓	✓	✓	✓
Tuning Control					
0 - 9	Digit input	✓	✓	✓	✓
CH +/-	Channel up/down	✓	✓	✓	✓
JUMP	Last channel	N/A	N/A	✓	N/A
Volume Control					
VOL +/-	TV volume +/-	N/A	✓	✓	AMP/RECEIVER Vol.
MUTING	Muting	N/A	N/A	N/A	✓
R/G/B/Y Control					
Red	Red	✓	N/A	✓	DVD or BD Input
Green	Green	✓	N/A	✓	VIDEO 1 or A/V Input
Blue	Blue	✓	N/A	✓	SAT or Cable Input
Yellow	Yellow	✓	N/A	✓	TV or Tuner Input

Exploring Fun Features

Favorites

With **Favorites**, you can manage your preferred **TV channels**, **External Inputs**, **Photo** content, **Music** content, and **Background TV** themes for easy access.

Displaying Favorites

Press **FAVORITES**.

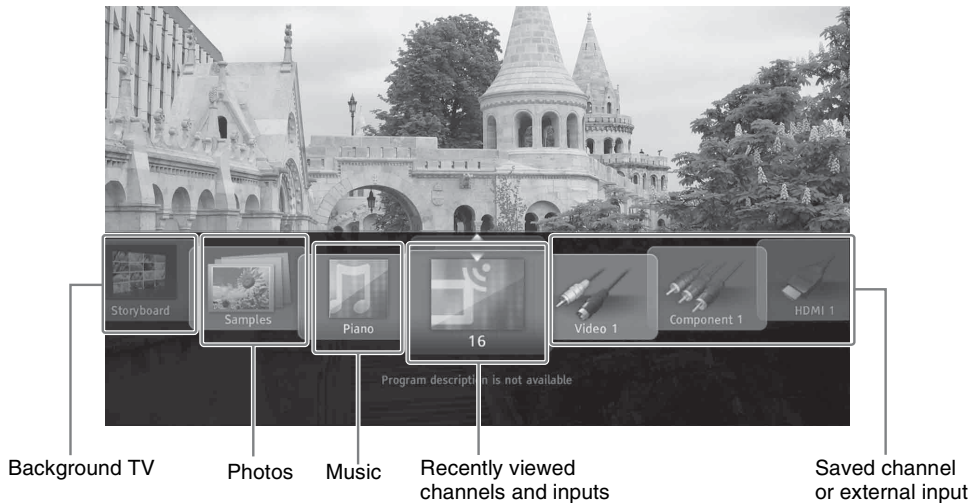

- The first time you enter **Favorites**, the recently viewed channels and inputs are highlighted.
- **Background TV** themes, built-in photos and music, and some inputs are automatically saved into **Favorites** as a factory default. To remove from **Favorites**, follow the instructions below.

Navigating Favorites

- 1 Press **←/→** to move between saved selections in a carousel-like fashion.
- 2 When the recently viewed channels and inputs are highlighted, press **▲/▼** to toggle between them.
- 3 To view an item, highlight its icon and press **⊕**.



- To clear your recently viewed channels and inputs list, highlight the list in **Favorites** and press **OPTIONS**, then select **Clear Recently Viewed**. Recently viewed items are also cleared when the TV is powered off.

Adding to Favorites

- 1 From the **XMB™**, select a **Photo**, **Music**, **TV**, or **External Inputs** icon. Locate the item you wish to add and press **OPTIONS**.
- 2 Press **▲/▼** to highlight **Add to Favorites** and press **⊕**.

Removing from Favorites

- 1 Press **FAVORITES**, then select an item to be removed, and press **OPTIONS**.
- 2 Press **▲/▼** to highlight **Remove from Favorites** and press **⊕**.



- **Auto Program** will clear your TV channels from **Favorites** (see pages 16 and 46).
- **Initial Setup** will return your **Favorites** to factory default settings (see page 52).

Background TV

Background TV displays images of current video on your TV that are similar to a screen saver. **Background TV** is available from the CABLE/ANTENNA, Composite, and DMPORT inputs.

Navigating Background TV

- 1 Tune to one of the inputs listed above.
- 2 Press **OPTIONS**.
- 3 Highlight **Background TV** and press \odot .
- 4 Highlight a theme and press \oplus . The TV will display the current channel or input using the selected **Background TV** theme.

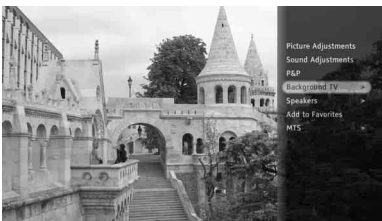

- 5 Press **RETURN** to exit the **Background TV** and return to the current channel or input.



- **Background TV** themes may also be saved to **Favorites**, so that you can launch these themes from the **Favorites** screen.

DLNA Certified™ Photo Media Player

This TV is a DLNA Certified digital media photo player that can display JPEG photo content from your DLNA Certified networked equipment.

After configuring the TV to an active network (see page 51), the available media servers will be found automatically and will be displayed under the **Photo** icon (see page 30). See **Show/Hide Servers** (page 51) to manually search for media servers.

Consult your DLNA Certified media server's operating instructions for more details on JPEG photo displaying capabilities. Sony does not guarantee that all media servers will display JPEG photos on this TV.



- Viewing content which is obtained between networked DLNA Certified equipment depends on the media formats supported by the DLNA Certified equipment.

Enjoying Photos and Music through USB Port

The TV offers easy access to JPEG photos and MP3 music files stored on Sony digital cameras (not supplied) connected via USB interface and Sony MICRO VAULT™ USB Flash Drives (not supplied).

Using USB Equipment

The USB port is located on the side TV panel.

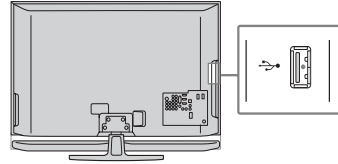

With the TV powered off, gently insert your USB equipment into the USB port and power on the TV. When inserted properly, it should slide in with little resistance. The TV will display “USB device detected”. For information on how to access **Photo** or **Music** files, see pages 30-33.

Removing USB Equipment

Power off the TV and slide the USB Equipment out of the USB port.

USB Equipment Functionality

Sony cannot guarantee or assure the USB functionality on this TV in the following cases:

- Use of non-Sony brand USB equipment
- Use of video or audio clips processed on a computer
- Use of files obtained from the Internet or from a printed film processing center.

Sony recommends backing up all data stored on USB equipment to avoid potential data corruption. Sony cannot accept responsibility for lost or damaged data recorded on USB equipment.

The USB functionality on this TV is designed to be compatible with various Sony brand digital cameras and MICRO VAULT USB Flash Drives, but not all. Sony cannot guarantee or assure compatibility with all formats or products.

Photo

The **Photo** feature allows easy access to JPEG files from Sony USB connected equipment and DLNA Certified media servers.

Accessing Photos

Under the **Photo** icon found on the **XMB™**, select the DLNA Certified media server, **USB**, or **Samples** icon to locate your photo files.

- 1 Press **HOME**.
- 2 Highlight and select the **Photo** category.
- 3 Press **▲/▼** to highlight and select the photo file location.

A sample DLNA Certified media server icon is shown below (actual icon may differ).



- 4 After locating your photo files, the **List View** will appear and display photo folders and files. Press **▲/▼** to highlight a file or folder and select (shown below with USB selected).

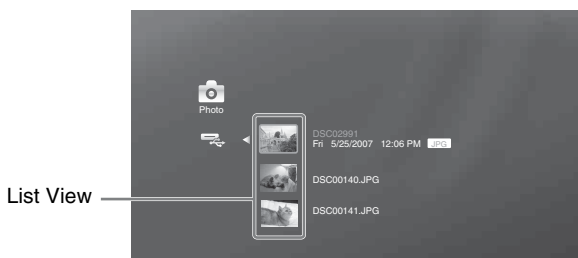

- ✍ To view available DLNA Certified media servers, your TV must be connected and configured to an active network (see page 51).
- The TV can display a maximum photo file size of 8 megabytes from DLNA Certified media servers.
- The photo display resolution range is 16 x 16 to 4,096 x 4,096 pixels.

Navigating through Photo

Use the remote control buttons described below to navigate through the feature.





Button	To do...	Button	To do...
OPTIONS	To access Photo Options menu	PLAY	To play a slideshow
	To play and pause a slideshow or select a folder	PAUSE	To pause a slideshow
RETURN	To stop slideshow and return to List View/Thumbnail View	STOP	To stop slideshow and return to List View/Thumbnail View

Photo Options

Pressing **OPTIONS** while displaying the **List View** will display the following Options menu.

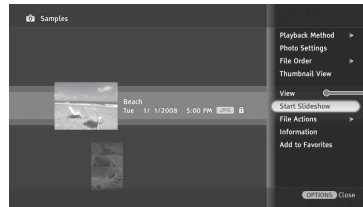

List View Options menu

Playback Method	Sets the Slideshow play mode and photo display order.
Repeat	Select On to continuously play the slideshow.
Shuffle	Select On to shuffle the photo order during the slideshow.
Photo Settings	Sets the Slideshow settings.
Slideshow Speed	Select from Fast , Medium , or Slow to set the photo display duration.
Slideshow Music	Select music to play during the slideshow. Tracks must be added in Music to be available for selection (see page 32).
Slideshow Effect	Select from Simple , Butterfly , Maze , Sepia , Monochrome , Slide , or Fade to set the slideshow transition or image effect (shown below is Butterfly effect).
	 <ul style="list-style-type: none"> • Maze and Butterfly slideshow effects can only display JPEG files.
	
	Display Preference Select to optimize picture display quality or display speed.
	Display Size Select to view photos in Standard or Expanded size.
File Order	Sets the order in which files will be listed. Select from Original , Alphabetical , Alphabetical Reverse , Date Order , or Date Order Reverse .
Thumbnail View	Select to fill the display screen with thumbnails.
View	Select to view the photo file highlighted.
Start Slideshow	Select to start the slideshow.
File Actions	Select to modify file settings for photos from a USB connected equipment.
	Rotate and Save Select to rotate a photo Right 90° , Left 90° , or 180° and save.
	Protection Select to protect a photo from deletion.
	Delete Select to delete a photo.
	Print Quantity Select to set Print Quantity and save to USB connected equipment.
	 <ul style="list-style-type: none"> • Not available with photos accessed from a DLNA Certified media server.
Information	Select to view photo folder, equipment, or server information.
Add to Favorites	Select to add a photo, folder, or equipment to Favorites .
Remove from Favorites	Select to remove from Favorites .

(Continued)

Pressing **OPTIONS** while displaying a photo will display the following Photo Options menu.



Picture Adjustments	Select to make adjustments to photos (see page 41 Picture Adjustments).
Sound Adjustments	Select to make sound adjustments (see page 43 Sound Adjustments).
Speakers	Select to set sound to TV Speakers or Audio System .



- For **Display Size**, **Playback Method**, **Photo Settings**, **Start Slideshow**, **Rotate and Save**, **Delete**, **Information**, **Add to Favorites**, and **Remove from Favorites** see page 31.
 - Photos cannot be stored in the TV.
-

Music

Listen to music MP3 files directly from a Sony connected USB equipment (not supplied) or add music to a slideshow.

Accessing Music

Under the **Music** icon, select the **USB** or **Samples** icon to locate your MP3 files.



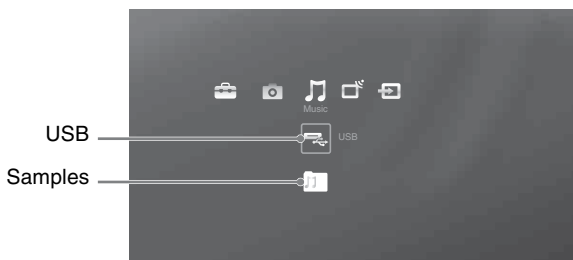

- 1 Press **HOME**.
- 2 Highlight and select the **Music** category.
- 3 Press **▲/▼** to highlight and select the music file location. A sample **USB** icon is selected below.



- 4 Music files and folders will be displayed in a **List View**. Highlight and select any available file or folder.

Navigating through Music

Use the remote control buttons described below to navigate through music tracks.

Button	To do...	Button	To do...
OPTIONS	To access Music Options menu	PAUSE	To pause or resume play of a music track.
	To play or pause a music, to select a folder or track	STOP	To stop playing a music track and return to List View/Thumbnail View .
	To play the previous music track		To navigate the List View or to play the previous/next music track
	To play the next music track		Press and hold to display control panel. Release to continue play.
PLAY	To play a track	RETURN	To navigate the List View/Thumbnail View .

Music Options

Pressing **OPTIONS** while displaying the **List View** will display the following Music Options menu.



Omit from Slideshow	Select to remove selected track from the slideshow music.
Playback Method	Sets the play order and visual effect settings while playing music files.
Repeat	Select On to continuously play tracks.
Shuffle	Select On to shuffle the track play order.
Track Selection	Select Single Track or All Tracks to play during a slideshow.
Visualizer Effect	Select Album Art , Bloom , or Burst visual effects during a track play (shown below is Burst effect).

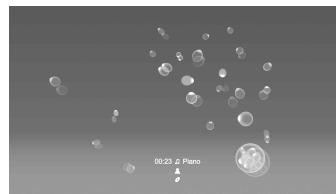

File Order	Sets the order in which files will be listed on the List View . Select from Original , Alphabetical , Alphabetical Reverse , Date Order , or Date Order Reverse .
Thumbnail View	Select to fill display screen with thumbnails.
Add for Slideshow	Select to make a music file accessible to play during slideshow. After adding a music file, see Slideshow Music under the Photo Options on page 31.
Information	Select to view track, folder, or equipment information.
Add to Favorites	Select to add a track, folder, or equipment to Favorites .
Remove from Favorites	Select to remove a track, folder, or equipment from Favorites .



- Music tracks cannot be stored in the TV.

How to Use TV Guide On Screen

Use the Guide to find the show that you want to watch. The Guide allows you to search for shows by program categories and by keyword. The Guide provides up to two days of TV programming information. The Guide is available with cable service (without a cable box) or over-the-air antenna. Be sure to complete the **Initial Setup** on page 16 to use this service.

TV Guide On Screen System Components

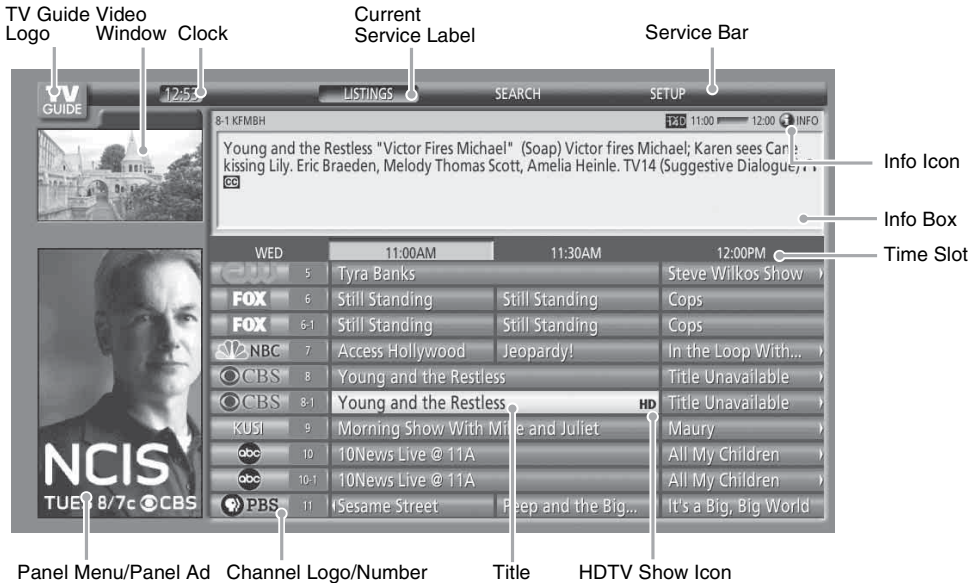

- Image shown above includes digital channels, which may not be available in some areas. If available, it may be necessary to manually change the channel display (see next page).

Use your TV's remote control to navigate the Guide system.

To Do This ...	Do This...
View TV Guide	Press GUIDE to display the TV Guide. Press GUIDE again to exit or press HOME to exit to XMB™ . The TV Guide will time out in approximately 5 minutes when no action is taken.
Find a program to watch	Use ▲/▼/◀/▶ to highlight a program. The CH+/- buttons can be used to page up/down through the listings. The program information will appear in the Info Box. Press (+) to tune to the highlighted program.
Return to Service Bar	Press RETURN while in the TV Guide, or press OPTIONS to display the Panel Menu then highlight the go to Service Bar and press (+) . You can also press ▲ repeatedly to access the Service Bar.
Use shortcuts	Shortcuts allow viewing of listings for a different time slot or jumping to a channel of your choice. Enter a number using 0-9 buttons while LISTINGS on the Service Bar is highlighted. The Panel Menu will appear as soon as you enter a number. Complete entering the number in the Shortcuts. The entered number will determine the channel or listing hours ahead or back to view the program. Press ▲/▼ to make your selection.

To Do This ...	Do This...
Search program	Press ▲/▼/◀/▶ to highlight SEARCH on Service Bar. You can search for programs using the following options: KEYWORD, ALPHABETICAL, MOVIES, SPORTS, CHILDREN, EDUCATIONAL, NEWS, VARIETY, SERIES and HDTV . Press ⊕ then press ◀/▶ to highlight your search option. Press ▲/▼ to narrow your search. Press ⊕ when you find the program. If the program is airing now, press ⊕ to watch.
Keyword search	Keyword search can be done by type, category or subcategory of a program. Highlight SEARCH on the Service Bar, press ⊕ then press ◀/▶ to highlight KEYWORD . Press ⊕ again or press OPTIONS to display Keyword Options in the Panel Menu. Select new search to narrow your search by type, category or subcategory by pressing ▲/▼/◀/▶ .
Customizing the TV Guide On Screen system settings	Highlight SETUP on the Service Bar then press ▼ to highlight the available options to customize your system settings. You can change system settings, change channel display, change default options, display setup progress and diagnostics information.
Change channel display	Highlight SETUP on the Service Bar then press ▼ to highlight the Change channel display then press ⊕ . Highlight a channel then press OPTIONS to display the Grid Options. Make the changes using ▲/▼ and/or 0-9 buttons. When the changes are made, select done and press ⊕ . The Grid Options can also be used to re-sort the channel display numerically. Display the Grid Options and select re-sort numerically then press ⊕ . Confirm the numerical re-sort by selecting yes to complete the task.
The Guide appears each time TV is turned on	Highlight SETUP on the Service Bar then press ▼ to highlight Change default options and then press ⊕ . Highlight General defaults and press ⊕ to display options in the Panel Menu. Set auto guide to on to have the Guide appear when the TV powers on.
Lock/unlock video	Allows you to set the Video Window display to remain on a single channel (locked) or change channels (unlocked) as you navigate through Listings. While in Service Bar, press OPTIONS to display the Listings Options in the Panel Menu. Press ◀/▶ to lock or unlock the video. The locked video option displays a single channel.

Using BRAVIA Sync with Control for HDMI

The BRAVIA Sync function on this TV communicates with other Sony equipment supporting the **Control for HDMI** function.

To connect Sony equipment with Control for HDMI

Use an HDMI cable that bears the HDMI logo for connection. See pages 12 to 15 or see the HDMI connection shown in the Quick Setup Guide provided with the TV documentation.

Setting the Control for HDMI

The **Control for HDMI** function must be set up in order for the TV to communicate with other **Control for HDMI** enabled equipment. See page 50 for information on how to set up this TV's **Control for HDMI** function. For other equipment, refer to its operating instructions.

Available options using Control for HDMI

The following operations are available after you connect the supported Sony equipment with **Control for HDMI** function to your TV:

- Automatically turn off the connected equipment when you turn off the TV.
- The TV will automatically turn on and select the respective HDMI input through the connected equipment by One-Touch-Play.
- Equipment listed under the **External Inputs** on the **XMB™** will turn on automatically when selected, see pages 5 and 38.
- Possible operations with **BRAVIA Sync** buttons, see page 19.

When a Sony A/V receiver with BRAVIA Sync is connected, the following additional operations are possible:

- Turning on the A/V receiver when the TV is turned on.
- Automatically switching to the audio output of the A/V receiver's attached speakers.
- Adjusting the volume and muting of the A/V receiver with the TV's remote control.



- The A/V receiver cannot be selected from the **XMB™**.

Using DIGITAL MEDIA PORT Adapter

Connecting a DIGITAL MEDIA PORT (DMPORT) adapter lets you display photos and play videos and music from a portable player on your TV.

The DMPORT adapter's menu and portable player can be controlled via the TV's remote control. The DMPORT input can be selected by pressing **INPUT**.

By pressing **◀▶**, **PLAY**, **PAUSE**, **▶▶** or **STOP** you may be able to navigate through the portable player's menu.



- Viewing the equipment's menu on the TV and controlling it via the TV's remote control depends on the equipment; refer to the portable player's operating instructions.
- Available DIGITAL MEDIA PORT adapters vary in each area.
- Do not connect an adapter other than the DIGITAL MEDIA PORT adapter.
- If the portable player is capable of sending video signals, then the DIGITAL MEDIA PORT will have video output. In this case, the system outputs a composite video signal.
- Check compatibility between portable player and the DIGITAL MEDIA PORT adapter.
- The output volume level between the DMPORT input and TV or other equipment input may be significantly different; adjusting the TV or other equipment's volume may be necessary.

Using P&P and PIP Features

This TV comes with the **P&P** and **PIP** features which allow you to view two pictures simultaneously. **P&P** (picture and picture) provides two windows side by side. **PIP** (picture in picture) provides PC input signal and TV channels.



- The CABLE/ANTENNA input must be connected to use the **P&P/PIP** features.
- **P&P** is not available with 1080/24p video format.
- **Closed Captions (CC)** is available with **P&P** and **PIP** (see page 47).

P&P

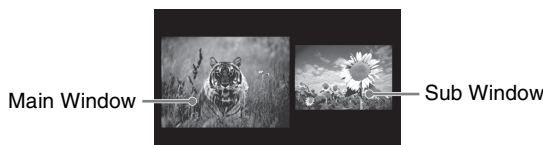

PIP



To Enter P&P and PIP

- 1 Press **OPTIONS** while watching one of the following inputs: TV channels, Video, Component, HDMI, DMPort or PC.
- 2 Press \uparrow/\downarrow to highlight **P&P** or **PIP** and press \oplus .

P&P Supported Inputs	
In main window	In sub window
Video 1/2/3	TV channel (CABLE/ANTENNA)
Component 1/2	
HDMI IN 1/2/3/4 (except PC timing)	
DMPort	

PIP Supported Inputs	
In main window	In sub window
PC	TV channel (CABLE/ANTENNA)
HDMI IN 1/2/3/4 (PC timing)	



- To swap audio in **P&P** mode, use the \leftarrow/\rightarrow button to swap the highlight between the Main Window and Sub Window.
- To swap audio in **PIP** mode, press **OPTIONS**, then press \uparrow/\downarrow to highlight **Audio Swap**.
- For compatible PC Timings, refer to the PC Input Signal Reference Chart (see page 14).

To Change Inputs or Channels (P&P)

Press \leftarrow/\rightarrow to highlight the window to change for **P&P**.

- In the main window, press **INPUT** to select an input to watch.
- In the sub window, change the channel by: pressing **CH+/-**; entering the channel number using the **0-9** numeric buttons; or pressing **JUMP** to switch to the previously viewed channel.

To Change Channels (PIP)

You can change the channel of the sub window by pressing **CH+/-**; entering the channel number using the **0-9** numeric buttons; or pressing **JUMP** to switch to the previously viewed channel.

To Exit from P&P and PIP

- 1 Press **OPTIONS**.
- 2 Press \uparrow/\downarrow to highlight **Exit P&P** or **Exit PIP** (depends on the mode you are in), and press \oplus to exit.



- You may also press **RETURN** while in these features to exit.
- Additional compatible device with TV tuner is required to watch two simultaneous live TV programs.

Using TV Settings



The **HOME** button allows you to access the **TV Home Menu** on the **XMB™** (CrossMediaBar) as well as a variety of TV features.

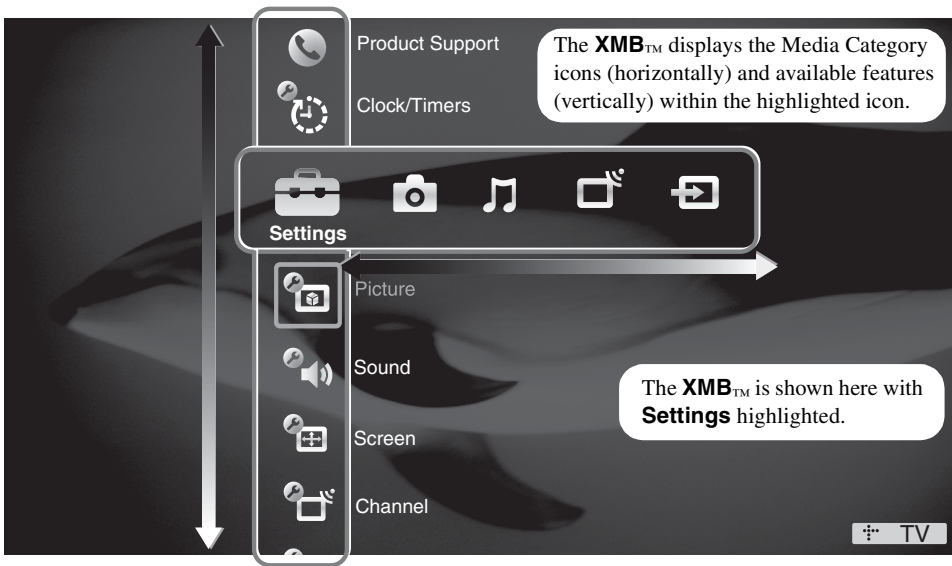

Media Category Icons



Settings

Adjusting TV Settings

Customize the TV settings with various options.

Explanations of different **Settings** start on page 40.

- The available options vary depending on the situations and conditions applied. Unavailable options are grayed out or not displayed.



Photo

Viewing Photos

View photos and customize slideshows (see page 30).



Music

Listening to Music

Listen to music or add a music track to a slideshow (see page 32).



TV

Watching TV

Navigate through the channel list or select the TV Guide On Screen icon located at the top of the channel list to select a channel (see page 34).

- You can also select a TV channel using the **0-9** or **CH+/-** buttons (see remote control section on pages 20 and 23).



External
Inputs

Accessing External Inputs

Watch a movie, play a game, record a program or work on your PC.

Assign a label using the **Manage Inputs** feature for your convenience (see page 50).

Navigating through TV Home Menu on XMB™

1  Press **HOME** to display the **XMB™**.

2  Press **←/→** to select a Media Category icon.

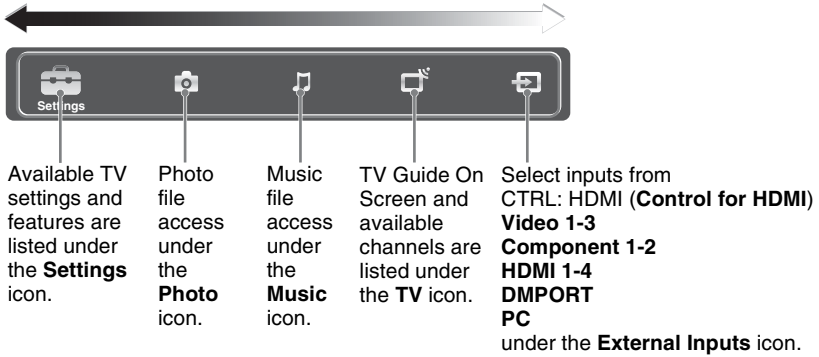

3  Press **↑/↓** to move within the Category Object Bar. (The Category Object Bar shown below is for **Settings**.)

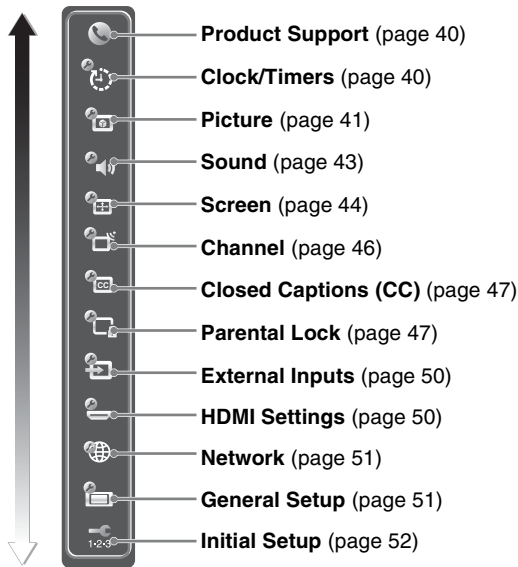

4  Press **⏏** when desired item is highlighted.

5  Press **⏏** or **↑/↓** to select the highlighted item.

6 
 Press **RETURN** or **HOME** to exit.

TV Settings Descriptions



Product Support

Contact Sony	Sony contact information is available from this screen for your convenience. Your TV's specific information such as Model Name, Serial Number, Software Version and downloadable ratings if available from the TV are displayed here.
Signal Diagnostics	Select to view the diagnostics information for the current signal.
Software Update	To view the current software version and check for software updates, the network must be connected to the TV or a broadcast download must be available (for U.S. customers only). Press ▲/▼ to choose the new version (if available) and press ⊕ to begin the software update.  <ul style="list-style-type: none">• The Cable/Antenna cable needs to be connected directly to the TV and have digital TV programming (not available with the use of a cable box).• The broadcast download is performed while the TV is off.• The software update is performed while the TV is powered on.• Do not turn off the TV during the software update, it may damage the TV software.



Clock/Timers Settings

Current Time	Set the current day and time (date, hour, minutes, and AM/PM). The Timer feature will not be available until you set the Current Time .  <ul style="list-style-type: none">• If the option is disabled, the TV Guide On Screen has automatically set the time.
Timer	Timer can be set to have the TV tune to a certain TV channel or other connected equipment as well as a specified volume at the specified time and duration you set. Turning on the Timer will allow setting the following: Day of the Week, Time, Duration, Input, Channel, and TV On Volume .
Sleep Timer	Sets the time in minutes (Off, 15 min, 30 min, 45 min, 60 min, 90 min, or 120 min) that you want the TV to remain on before shutting off automatically.



Picture Settings

Picture Adjustments	Picture Mode <i>For Video</i>	Vivid	For enhanced picture contrast and sharpness.	
		Standard	For standard picture settings. Recommended for home entertainment.	
		Cinema	For viewing film-based content. Most suitable for viewing in a theater-like environment.	
	For Photo	Custom	Allows you to store your preferred settings.	
		Photo-Vivid	For enhancing contrast and sharpness.	
		Photo-Standard	For standard viewing; select for home use.	
		Photo-Original	Images resemble the printed pictures from your photo album.	
		Photo-Custom	Allows you to store your preferred settings.	
	For PC Timings	Video	This option is available for PC timing (HDMI or PC input) signal to enhance the video shown on the screen.	
		Text	This option is available for PC timing (HDMI or PC input) signal to enhance the text shown on the screen.	
				
	<ul style="list-style-type: none"> • Picture Mode for all inputs can also be accessed by pressing PICTURE on the remote control to directly toggle the modes. • The options for Picture Mode may vary depending on the Video/Photo Optimizer setting (see page 43) and PC input. 			
	Reset	Resets the current settings to the default values.		
	Backlight	Brightens or darkens the backlight.		
	Picture	Increases or decreases picture contrast.		
	Brightness	Brightens or darkens the picture.		
	Color	Increases or decreases color intensity.		
	Hue	Increases or decreases the green tones.		
Color Temperature <i>White adjustment</i>	Cool	Gives the white colors a bluish tint.		
	Neutral	Gives the white colors a neutral tint.		
	Warm 1, 2	Gives the white colors a reddish tint.		
				
<ul style="list-style-type: none"> • The option Warm 1, 2 is not available for Vivid and Photo-Vivid. 				
	Sharpness	Sharpens or softens the picture.		
	Noise Reduction	Reduces the picture noise level.		
	MPEG Noise Reduction	Reduces the mosaic effect in MPEG-compressed video. Useful for DVDs, Blu-ray and digital TV channels.		

Advanced Settings	Available in the following Picture Modes: Standard, Cinema, Custom, Photo-Standard, Photo-Original, and Photo-Custom.
Reset	Resets all the advanced settings to the default values.
Black Corrector	Enhances black areas of the picture for stronger contrast.
Advanced C.E. (Advanced Contrast Enhancer)	Automatically optimizes the backlight and contrast. This setting is especially effective for dark picture scenes.
Gamma	Adjusts the balance between light and dark areas of the picture.
Clear White	Emphasizes white and light colors.
Color Space	Selects the range of color reproduction from Wide or Standard .
Live Color	Available when Color Space is set to Wide . Makes colors more vivid and reproduces clear skin tones.
White Balance	Adjusts the color temperature in detail.



- **Picture** settings for all inputs can also be accessed by pressing **OPTIONS** on the remote control, then selecting **Picture Adjustments** settings from the **OPTIONS** menu.
- **Picture** settings available during PC input are **Picture Mode, Reset, Backlight, Picture, Brightness, and Color Temperature**.

Motion Enhancer	Activates Motionflow to enhance the smoothness of picture movement and to reduce blur.
High	Provides smoother picture movement for film-based content.
Standard	Provides smooth picture movement. Use this setting for standard use.
Off	Use this setting when the High and Standard settings result in video artifacts such as ghosting.



- A noticeable change may be seen depending on the video.
- **Motion Enhancer** is not available when **Game Mode** is set to **On**.

CineMotion	Automatically detects film-based content and applies an inverse 3-2 pull-down process and a motion estimation engine to improve film content and de-interlacing performance.
Auto 1	Applies an inverse 3-2 pull-down process along with motion estimation to obtain the smoothest picture quality and reduces artifacts of moving images. Select for standard use.
Auto 2	Applies only the inverse 3-2 pull-down process. Picture movement will be similar to the original film.
Off	Turns off CineMotion .



- The **CineMotion** feature can be set separately for each input (except PC IN).

Game Mode	Select On to optimize the enjoyment of fast paced video games where response time is important. Select Off to disable this feature.
	 <ul style="list-style-type: none"> The Game Mode can be set separately for each external input (except PC IN).
Video/Photo Optimizer	Sets the picture settings to optimize the image quality of video (moving pictures) or photo (still image) content. Feature is only available for 1080i/p (excluding 1080/24p) content connected to the Component or HDMI input.
Video-A	The TV will automatically set the picture settings for video or still image content when Sony optional equipment that supports Video-A mode is connected to the HDMI input.
Video	Select to set the picture settings for video.
Photo	Select to set the picture settings for photos.



• **Game Mode** and **Video/Photo Optimizer** features are not available when **Theater Mode** is set to **On**.

Sound Settings

Available **Sound** settings depend on the **Speakers** setting.

Sound Adjustments	Sound Mode	Dynamic	Enhances treble and bass.
		Standard	Standard sound optimized for home use.
		Clear Voice	Suitable for spoken dialog.
	Reset	Resets the current settings to the default values.	
	Treble	Increases or decreases higher-pitched sounds.	
	Bass	Increases or decreases lower-pitched sounds.	
	Balance	Emphasizes left or right speaker balance.	
	Surround	S-FORCE Front Surround	Provides a virtual surround sound experience made possible using just two front speakers.
		Off	Select for normal stereo or mono reception.
	Voice Zoom	Adjusts the clarity of human voices. For example, if the voice of a news announcer is indistinct, you can turn up this setting to make the voice clearer. Conversely, if you are watching a sports program, you can turn down this setting to soften the voice of the commentator.	
	Sound Booster	The Sound Booster provides a fuller sound with a greater sense of depth and width, by emphasizing the high and low frequency sounds. Select High , Low or Off for the amount of boost you desire. Selecting Off will bypass the emphasis.	





• Only available when in **Standard** mode.

Steady Sound	Select On to stabilize the volume across all programs and commercials. Select Off to disable this feature.
Volume Offset	Adjusts the volume level of the current input (TV or video input) relative to other inputs.



• **Sound Adjustments** can also be accessed by pressing **OPTIONS** on the remote control.

MTS <i>Enjoy stereo, bilingual and mono programs</i>	Stereo	For stereo reception when viewing a TV program broadcasted in stereo.
	Auto SAP	Automatically switches the TV to second audio programs when a SAP signal is received. If no SAP signal is present, the TV remains in Stereo mode.
	Mono	For mono reception. Use to reduce noise during weak stereo broadcasts.
		
<ul style="list-style-type: none"> • MTS is available only for analog programs. • MTS can also be accessed by pressing OPTIONS on the remote control. 		
Speakers	TV Speakers	Select to use the TV speakers for audio.
	Audio System	Select this option if you wish to use an external audio system for the TV sound. By selecting this option you are disabling the TV speakers.
Audio Out <i>Easy control of volume adjustment</i>	Fixed	Select to fix the audio output and allow you to adjust the volume with your audio system's remote control. (The TV's remote control's VOL and MUTING buttons have no effect on the Audio Out .)
	Variable	Select to control the volume of your TV's speakers or audio system with your TV's remote control.
Woofers Level	Increases or decreases the low frequency sounds.	

- 
- **Alternate Audio** is available only for digital programs. If the program you are watching is also available in other languages from the audio tracks, and if that language is what you have selected in the **Language** setting, your TV will automatically switch to the matching language with the **Alternate Audio** feature. The **Alternate Audio** option may be accessed by pressing **OPTIONS** on the remote control when an alternate audio stream is available from the broadcaster.

Screen Settings

Wide Mode	Wide Zoom	Fills the screen with minimum distortion.
	Normal	Displays the 4:3 picture in its original aspect ratio when the original source is 4:3.
	Full	Enlarges the picture horizontally to fill the screen when the original source is 4:3. When the original source is 16:9 (High-definition source), select this mode to display the 16:9 picture in its original size.
	H Stretch	Enlarges the picture horizontally to fill the screen when the original source is 16:9. It is useful for HD channels with 4:3 content.
	Zoom	Select to enlarge the picture horizontally and vertically to fill the screen while maintaining the aspect ratio.
		
<ul style="list-style-type: none"> • Wide Mode can also be accessed by pressing WIDE on the remote control. • See WIDE button description on page 21 for accessing the Wide Mode. • Normal is available with 480i or 480p sources only. • H Stretch is only available with 720p, 1080i, 1080p and 1080/24p sources. 		
Auto Wide	On	Automatically changes Wide Mode setting based upon content. If frequent screen changes are disturbing to you, select Off .
	Off	Turns off the Auto Wide option. Choose a Wide Mode from the Wide Mode option.

4:3 Default <i>Select the default screen mode to use for 4:3 sources</i>	Wide Zoom	Enlarges the 4:3 picture to fill the 16:9 screen, displaying as much of the original image as possible.
	Normal	Displays the 4:3 picture in its original aspect ratio.
	Full	Select to enlarge the 4:3 picture horizontally only, to fill the screen.
	Zoom	Select to enlarge the picture horizontally and vertically to fill the screen while maintaining the aspect ratio.
	Off	Select to continue using the current Wide Mode setting when the channel or input is changed.



- **4:3 Default** is not available if **Auto Wide** is set to **Off**.
- If **4:3 Default** is set to anything but **Off**, the **Wide Mode** setting applies only to the current channel. When you change channels (or inputs), **Wide Mode** is automatically replaced with the **4:3 Default** setting for 4:3 sources. To retain the current **Wide Mode** setting as channels and inputs are changed, set **4:3 Default** to **Off**.

Display Area	Full Pixel	Displays the picture for 1080i, 1080p or 1080/24p sources in its original size.
	Normal	Displays the picture in its original size.
	-1/-2	Enlarges the picture to hide the edges of the picture.



- For 720p, 1080i, 1080p and 1080/24p, feature is only available when **Wide Mode** is set to **Full**.

Screen Position	Adjust the Vertical positioning by pressing \uparrow/\downarrow . Press \leftarrow/\rightarrow to adjust the Horizontal positioning.
------------------------	--



- **Screen Position** feature is useful if the TV is connected to game equipment.
- Vertical position is available only when **Wide Mode** is set to **Zoom**.
- For high-definition signals, **Vertical** and **Horizontal** positions are not available.

Vertical Size	Adjusts the vertical size of a standard-definition picture.
----------------------	---



- **Vertical Size** is available only when **Wide Mode** is set to **Wide Zoom** or **Zoom** for standard-definition channels.

Screen settings for PC timings and HDMI-PC (PC input) differ from all other input modes and are shown below.

Auto Adjust	Select Yes to start the auto adjust for the PC input.
Reset	Resets the settings to the default values.
Phase	Adjust after Pitch to fine tune overall sharpness.
Pitch	Adjust uneven sharpness on screen.



- For the PC Input Signal Reference Chart, see page 14.

H Center	Allows you to move the position of the picture horizontally (left and right).
-----------------	---

V Center	Allows you to move the position of the picture vertically (up and down).
-----------------	--

Wide Mode	Normal	Select to display the picture in its original resolution and aspect ratio.
	Full 1	Select to enlarge the picture to fill the screen, while maintaining its original aspect ratio.
	Full 2	Select to enlarge the picture to fill the screen.



- **Wide Mode** can also be accessed by pressing **WIDE** on the remote control.
- See **WIDE** button description on page 21 for accessing **Wide Mode**.



- **Phase** and **Pitch** options are not available with PC signal connected to HDMI input.



Channel Settings

Signal Type	Cable	For receiving cable channels via cable TV provider.
	Antenna	For receiving signal via over-the-air antenna.

 • You should run **Auto Program** after changing the **Signal Type** setting.

Auto Program	Automatically sets the channel list in the TV for all receivable channels. Channel scanning will be based on the Signal Type (Cable/Antenna) setting.
---------------------	--

- 1 Select **Auto Program**.
- 2 Select **OK** to start **Auto Program**. When **Auto Program** is completed, the screen will display the number of channels found.
- 3 Press **RETURN** to exit **Auto Program**.



- Running **Auto Program** will clear the **Favorites** channel list for the current signal type.
- If you run **Auto Program** again, previously scanned channels will be overwritten with the newly scanned channels.

Add Digital Channels	Select to add digital channels. Be sure to have the Signal Type option selected appropriately for the signal source. (Useful for antenna installations.)
-----------------------------	---

Show/Hide Channels	Allows you to show or hide channels when you surf with the CH +/- button or in the TV channel list on the XMB™ .
---------------------------	---

- 1 Press **▲/▼** to scroll through the channels until you highlight the channel to show or hide.
- 2 Press **⊕** to select **Shown** or **Hidden**.
To show or hide more channels, repeat steps 1-2.



- **Hidden** channels can be accessed by entering the channel number with **0-9** buttons on the remote control.

Edit Channel Labels	Assigns labels (such as station call letters) to channel numbers.
----------------------------	---

- 1 Press **▲/▼** to scroll through the channel numbers. Then press **⊕** to select the channel number to assign a label.
- 2 Press **▲/▼** to scroll through the label characters (A-Z, 0-9, etc.). Press **▶** to move to the next character. Repeat to add up to 7 characters to the label. Press **⊕** to set it.
To assign labels to more channels, repeat steps 1-2.



- This feature is not available when using the TV Guide On Screen system.



Closed Captions (CC) Settings

CC Display	This option allows you to view Closed Captions (CC) .
On	Enables CC Display .
Off	Disables CC Display .
On with Muting	Automatically displays closed captions when the TV is muted.
Analog CC	For the basic analog (EIA-608) closed caption options.
CC1, CC2, CC3, CC4	Displays a printed version of the dialogue or sound effects of a program. (Should be set to CC1 for most programs.)
Text1, Text2, Text3, Text4	Displays network/station information presented using either half or the whole screen (if available).
Digital CC	For both analog (EIA-608) and digital (EIA-708) closed caption options. Select from Service 1-6 and CC1-4 (advanced digital closed caption options).
Display Options	Customize the Closed Captions (CC) displays with Text, Character Size, Character Style, Character Color, Character Opacity, Edge Type, Edge Color, Background Color and Background Opacity .



- **Closed Captions (CC)** can be turned **On, Off** or **On with Muting** directly by pressing **CC** on the remote control.



Parental Lock Settings

The **Parental Lock** feature allows you to block programs according to their content and rating levels and block channels (regardless of the programs). Password is necessary in setting up blocking.



- The **Parental Lock** feature is also available with Video and Component (480i) inputs.

To View Blocked Programs

Press **ENT** when tuned to a blocked program, then enter the password. To reactivate the **Parental Lock** settings, turn off and on the TV.

Password	Use 0-9 button on the remote control to enter a four-digit password. The first time the password is created, you must re-enter it again to confirm the password. "Password set" message will appear on the screen upon confirmation. Change Password You can change your password by entering the Parental Lock setting with the previously set password. Highlight and select Change Password , then enter the new password.
	 • You need your password for any future access into the Parental Lock settings. If you lose your password, see "Lost password" on page 56.
Country	Select the country name of U.S.A. or Canada for the appropriate ratings. The rating system varies between these two countries. See Custom Rating System Chart on page 49.

Rating	Off	Turns off Parental Lock . No programs are blocked from viewing based on their ratings.
	Child	Ratings permitted are: United States TV Rating: TV-Y, TV-G MPAA: G Canada English TV Rating: C, G French TV Rating: G
	Youth	Maximum ratings permitted are: United States TV Rating: TV-PG MPAA: PG Canada English TV Rating: PG French TV Rating: 8 ans+
	Young Adult	Maximum ratings permitted are: United States TV Rating: TV-14 MPAA: PG-13 Canada English TV Rating: 14+ French TV Rating: 13 ans+
	Custom	Sets ratings manually. U.S.: See page 49 for details. Canada: See page 49 for details.



- If you are not familiar with the parental guideline rating system, you should select **Child**, **Youth**, or **Young Adult** to help simplify the rating selection. To set more specific ratings, select **Custom**.

Digital Rating (Available only in U.S.A. where advanced ratings exist)	Off	Turn Digital Rating off. No programs containing digital ratings are blocked from viewing.
	Custom	Select to customize the Parental Lock with downloadable digital ratings.
	Clear All	Select to clear the downloaded ratings.

Unrated (Available only when Country is set to U.S.A.)	Allow	Allows programs and movies that are broadcasted without a rating.
	Block	Blocks all programs and movies that are broadcasted without a rating.



- If you block unrated TV programs, be aware that the following types of programs may be blocked: programs broadcast from another country, emergency broadcasts, political programs, sports, news, public service announcements, religious programs and weather.

Channel Block Allows you to block specific channels regardless of program ratings. The password needs to be set up prior to blocking channels. The blocked channel can only be viewed by entering the correct password.

To View a Blocked Channel

Press **ENT** when tuned to the blocked channel then enter the password.

Custom Rating System Chart

For **Country** selection of **U.S.A.**:

Movie Rating	G	All children and general audience	
	PG	Parental guidance suggested	
	PG-13	Parental guidance for children under 13	
	R	Restricted viewing, parental guidance is suggested for ages under 17	
	NC-17 and X	No one 17 or under allowed	
TV Rating <i>Block programs by their rating, content or both</i>	Age-Based Ratings		
	TV-Y	All children	
	TV-Y7	Directed to children age 7 and older	
	TV-G	General audience	
	TV-PG	Parental guidance suggested	
	TV-14	Parents strongly cautioned	
	TV-MA	Mature audience only	
	Content-Based Ratings		
	FV	Fantasy violence	
	D	Suggestive dialogue	
	L	Strong language	
	S	Sexual situations	
	V	Violence	
		<ul style="list-style-type: none"> To ensure maximum blocking capability, set the Age-Based Ratings. 	

For **Country** selection of **Canada**:

English Rating	C	All children
	C8+	Children 8 years and older
	G	General programming
	PG	Parental guidance
	14+	Viewers 14 and older
	18+	Adult programming
French Rating	G	General programming
	8 ans+	Not recommended for young children
	13 ans+	Not recommended for ages under 13
	16 ans+	Not recommended for ages under 16
U.S.A. Rating	18 ans+	Programming restricted to adults
	See TV Rating under U.S.A. for details.	



External Inputs Settings

Manage Inputs

Follow the steps below to customize your input menu for easy recognition when the **INPUT** button is pressed or when selecting an input from the **XMB™**.

- 1** Press **▲/▼** to highlight your input selection.
- 2** Press **⊕** to set **Enable** setting to either **Always** or **Auto**. The **Always** option will display this input in the input menu at all times. With the **Auto** option, the input with connected icon will only appear when external equipment is connected and/or an HDMI signal is present. Some external equipment may not be detected automatically.
- 3** To assign your own label to the input, press **▶** to highlight the label option, then press **▲/▼** to choose a name of the equipment that is connected to this input.



- You can assign the following labels for each input (except PC IN and DMPort):
–, DVD, Cable Box, Satellite, BD, VCR, Receiver, DVR, Game, Camcorder, PC.
- “–” indicates that no labels are assigned.

Channel Tuning Keys

This setting controls how the remote control channel tuning keys (**0-9, CH+/-** and **JUMP**) behave while using an external input.

- | | |
|-----------------|--|
| Enabled | Select to allow the TV to exit from the external input and return to a TV channel when pressing the tuning keys. |
| Disabled | Select to disable the tuning keys during external input mode and prevent unintentionally exiting the external input. |



- Useful for applications that do not have a connection to the CABLE/ANTENNA input.



HDMI Settings

HDMI inputs of this TV will recognize and communicate with other Sony equipment equipped with **Control for HDMI** function.

Control for HDMI

On/Off feature allows your TV to communicate with other equipment that supports **Control for HDMI** function.

Device Auto Power Off

Select **On** to have your connected equipment with **Control for HDMI** function to power off automatically when the TV is turned off. Select **Off** to disable this function. This feature is available when **Control for HDMI** is **On**.

TV Auto Power On

Select **On** to control your TV's power on from your connected equipment with **Control for HDMI** function. Select **Off** to disable this function. This feature is available when **Control for HDMI** is **On**.

Device List

Displays a list of equipment with **Control for HDMI** function connected to the TV.



- Press **OPTIONS** while the equipment supporting **Control for HDMI** is connected to display the **Device Control** options. The **Device Control** option provides access to the **Menu, Options** and **Content List** of your connected equipment with your TV remote control.
- Some equipment with **Control for HDMI** does not support the **Device Control** feature.





Network Settings



Network Setup	Select to configure your TV's accessibility to your network via an Ethernet cable and configure Network Setup or review your TV's current network settings. Select your preferred configuration type.
Easy	The TV will automatically configure your network settings. Most networks can be configured with this option.
Custom	This option allows you to manually enter the IP address and proxy settings (FOR ADVANCED USERS ONLY).
Auto	Select to populate the IP address and jump to the proxy setting selection.
Manual	Select to manually enter an IP address. If you would like to use a proxy setting, select Use , if not, select Don't Use .
Review	Select to view current network settings.
Show/Hide Servers	Allows you to show or hide available DLNA Certified media servers. When in Show/Hide Servers menu, press OPTIONS to display the items below.
Delete All	Select to delete all connected servers.
Update List	Select to update the server list.
Details	Select to display the detailed information of the connected server.
Delete	Select to delete the highlighted server.
	 <ul style="list-style-type: none"> The items above can only be accessed by pressing OPTIONS while in the Show/Hide Servers menu.
Server Diagnostics	Select to view the server diagnostic information.



General Setup Settings

Language	Select the language of your choice from English, Español and Français to be used for displaying all the on-screen settings.
Info Banner	Displays the program name and the program information such as program title and program rating (if available from the broadcaster). Select the amount of program information to display when tuning.
Small	Select to display minimal channel and program information.
Medium	Select to display channel and program information.
Large	Select to display detailed channel and program information.
	 <ul style="list-style-type: none"> Info Banner appears on the screen each time the channel and external inputs are changed or when DISPLAY on the remote control is pressed.
USB Auto Start	Select to automatically display photos when a camera is connected via USB.
Slideshow	Select to view JPEG files as a Slideshow .
Thumbnail View	Select to view JPEG files up to 60 thumbnails at a time.
Off	Select to disable this function.
	 <ul style="list-style-type: none"> Press HOME on the remote control to exit this function.

(Continued)

Home Menu Scrolling	Adjust the navigation speed through menu items.
	Standard Select to scroll quickly with ▲/▼ buttons.
	Mode 1 Select to scroll slowly with ▲/▼ buttons.
	Mode 2 Select to scroll individually with repeated ▲/▼/◀/▶ button press.
Power Saving	Reduces the power consumption by adjusting the backlight brightness. This also enhances the black level. Select from Off , Low , High and Picture Off .
	 <ul style="list-style-type: none"> • While Picture Off is set, pressing VOL +/- or MUTING buttons will not disable this function. Press other buttons to disable it.
Light Sensor	Enables the automatic picture (screen) brightness control. The Light Sensor measures the room brightness which allows the TV to automatically adjust the backlight brightness based on the picture settings and the ambient room light conditions.
	 <ul style="list-style-type: none"> • Be sure not to put anything around the sensor, as its function may be affected (see page 18). • In low light the range of the backlight control is reduced when the Light Sensor is set to On.
PC Power Management	Select On to have the TV automatically enter standby mode when there is no signal input for more than 30 seconds. The STANDBY LED on the front panel illuminates with the On option. Select Off to disable this feature.
	 <ul style="list-style-type: none"> • Press POWER to exit from standby mode. • PC Power Management is not VESA-compliant.
Logo Illumination	Select On to illuminate the SONY logo on the front panel or select Off to disable this function.
Picture Adjustments Lock	Select Lock to prevent the picture adjustments from being changed. To disable this feature and allow picture adjustments, select Unlock .

Initial Setup 1·2·3

If you missed the **Initial Setup** when you first connected the TV or if you want to scan all receivable channels, select **Initial Setup**. Follow the instructions on the screen. Some settings such as **Picture Adjustments**, **Sound Adjustments**, and **Parental Lock** will not be affected by this **Initial Setup**. If you wish to return your TV to factory settings, please see the Troubleshooting section on page 56.



- **Favorite** channel list will be cleared each time you run the **Initial Setup**.

Other Information

Troubleshooting

If you have questions, service needs, or require technical assistance related to the use of your Sony TV, please visit our website or call one of the following numbers:

<http://www.sony.com/tvsupport> for US Support
<http://www.sony.ca/support> for Canadian Support
 1-800-222-SONY(7669) for US Support
 1-877-899-SONY(7669) for Canadian Support

Condition	Explanation/Solution
No picture	
No picture	<ul style="list-style-type: none"> • Check the Power Saving settings (see page 52).
Cannot receive any channels	<ul style="list-style-type: none"> • Make sure the power cord is connected securely. • Turn on the power of the TV. • Check cable/antenna connections. • Make sure the Signal Type setting is correct for your TV signal source.
TV is locked to one channel	<ul style="list-style-type: none"> • Perform Auto Program to add receivable channels that are not present in the TV's memory (see pages 16 and 46).
Cannot receive or select channels	<ul style="list-style-type: none"> • Perform Auto Program to add receivable channels that are not present in the TV's memory (see pages 16 and 46). • To receive or select cable channels, make sure that Signal Type in the Channel settings is set to Cable (see page 46). To receive or select UHF channels over an antenna, make sure Signal Type is set to Antenna.
The TV turns off automatically	<ul style="list-style-type: none"> • Check if Sleep Timer is activated, or confirm the Duration setting of Timer (see page 40). • Check PC Power Management in General Setup settings (see page 52).
No picture from some video sources	<ul style="list-style-type: none"> • Check the connection between the optional video equipment and the TV. • Press INPUT on the remote control (see page 22). • Press HOME on the remote control. Select your desired input from the External Inputs list.
Poor picture	
Picture quality not as good as viewed at the store	<ul style="list-style-type: none"> • Picture quality depends on the signal content. See Quick Setup Guide (supplied) to display the best possible picture for that signal.
Broadcast HD formats have poor quality	<ul style="list-style-type: none"> • Content and signal quality are regulated by the signal provider. Many HD channels and content are actually upscaled versions of standard-definition broadcasts. The picture is affected by the quality of the signal received, which varies between channel and program. • Confirm the picture quality by selecting Signal Diagnostics in the Product Support settings (page 40). Then select Sample Image (or Additional Information first). An HD image will display on the screen to confirm routine panel operation. If your normal picture quality is worse than this sample image, it is most likely due to the signal provided by the broadcaster.
Double images or ghosts	<ul style="list-style-type: none"> • Check cable/antenna connections. • Check the antenna location and direction. • Set the Motion Enhancer to Standard or Off (see page 42).
Only snow and noise appear on the screen	<ul style="list-style-type: none"> • Check if the antenna is broken or bent. • Check if the antenna has reached the end of its serviceable life. (3-5 years in normal use, 1-2 years at the seaside.)
Dotted lines or stripes	<ul style="list-style-type: none"> • Keep the TV away from noise sources such as cars, motorcycles, or hair-dryers. • If using 300 ohm twin lead, move the excess lead away from the TV or try using 75 ohm coaxial cable instead.

(Continued)

Condition	Explanation/Solution
No color / Dark picture / Color is not correct / The picture is too bright	<ul style="list-style-type: none"> • Press PICTURE to select the desired Picture Mode (see page 22). • Adjust the Picture Mode options in the Picture settings (see page 41). • If you set the Power Saving mode to Low or High, it will enhance the black level (see page 52).
Noisy picture	<ul style="list-style-type: none"> • Make sure that the antenna is connected using a 75-ohm coaxial cable. • Keep the antenna cable away from other connecting cords. • To avoid TV interference, make sure to use an undamaged antenna cable.
Blurry picture / Poor color	<ul style="list-style-type: none"> • Transporting the TV from a cold to a warm location or a sudden change in room temperature may cause moisture condensation, resulting in a blurry picture or poor color. Turn off your TV and wait a few hours before powering on again.
No sound / Noisy sound	
No sound / Good picture	<ul style="list-style-type: none"> • Check the volume control. • Press MUTING or VOL + so that “Muting” disappears from the screen (page 20). • Set Speakers to TV Speakers in the Sound settings (see page 44). If it is set to Audio System, sound is not output from the TV’s speakers regardless of the TV’s volume control. • When using HDMI input with Super Audio CD or DVD-Audio, DIGITAL AUDIO OUT (Optical) may not provide an audio signal. • When tuned to a digital channel with Alternate Audio, the broadcaster may not be broadcasting your preferred Alternate Audio language. Press OPTIONS, highlight and select Alternate Audio, and change the Alternate Audio language (see page 44).
Audio noise	<ul style="list-style-type: none"> • Make sure that the antenna is connected using a 75-ohm coaxial cable. • Keep the antenna cable away from other connecting cords. • To avoid TV interference, make sure to use an undamaged antenna cable.
No Audio or Low Audio with Home Theater System	<ul style="list-style-type: none"> • Press THEATER for BRAVIA Sync activated Theater System (see page 19). • Set Speakers to Audio System in the Sound settings (see page 44). • Set Audio Out to Fixed in the Sound settings (see page 44).
BRAVIA Sync	
Cannot find connected BRAVIA Sync HDMI device	<ul style="list-style-type: none"> • Make sure that the Control for HDMI is set up on both the TV and the optional device compatible with BRAVIA Sync (see page 36).
Cannot control second AV receiver	<ul style="list-style-type: none"> • Only one A/V receiver may be used with the BRAVIA Sync and Control for HDMI functions at one time (see page 50).
DLNA	
DLNA Certified™ Photo Media Player is not connecting to the server	<ul style="list-style-type: none"> • Check the LAN cable/connection to your server and your TV. • Check if your network is properly configured on your TV. See Network Setup on page 51.
When “Network disconnected” appears on your TV screen	<ul style="list-style-type: none"> • Check the current network settings. From the Network icon located on the XMB™, select Network Setup, then the Review option. If all of your network settings are 0.0.0.0, your server may not be connected properly. Check your network connections and/or server’s instruction manual for connection information. • Reconfigure your network settings. See Network Setup on page 51. • If the LAN cable is connected to an active server and the TV has acquired an IP Address, check your DLNA Certified media server’s connections and configurations. <p></p> <ul style="list-style-type: none"> • Your IP Address configuration can be viewed by selecting the Review option. See Network Setup on page 51.
DLNA Certified™ server is listed under the Photo icon, but is inaccessible	<ul style="list-style-type: none"> • The TV may have lost connection with the server, check your LAN cable/connection or your server connections.

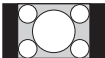
Condition	Explanation/Solution
PC Input	
No picture / No signal	<ul style="list-style-type: none"> • Confirm the PC is correctly connected to the TV with either the PC IN (with an HD15 cable) or with the HDMI IN. • Ensure the output signal from the PC is one of the formats listed on page 14. • Turn the PC off. Confirm the PC connection and restart the PC. Plug-and-play will auto-detect the TV and correctly set up PC timing. • Verify PC Power Management is activated (see page 52). • Verify the PC is not in standby or hibernation mode.
Poor Picture	<ul style="list-style-type: none"> • Adjust the resolution (see page 14). • Adjust Pitch and Phase.
General	
Wide Mode changes automatically	<ul style="list-style-type: none"> • The current Wide Mode setting is automatically replaced with the 4:3 Default setting when you change the channel or video input, if 4:3 Default in the Screen settings is set to other than Off. If you want to lock in Wide Mode selected with WIDE on the remote control, set 4:3 Default to Off in the Screen settings (see page 44). • Check the Auto Wide option in the Screen settings (see page 44).
Suddenly the picture gets smaller 	<ul style="list-style-type: none"> • The picture gets smaller during the commercials due to the method in which the provider broadcasts their content. When HD content channels switch to SD content (commercials), the picture may be small with a black border. • Auto Wide will not expand the picture during these content changes since the content information is regulated by the channel signal provider. You can manually change the Wide Mode if you prefer (see page 21). This setting will remain in effect until you change the channel or input or manually change the Wide Mode again.
“Black box” on screen	<ul style="list-style-type: none"> • You have selected a text option and no text is available (see page 47). To turn off this feature, set the CC Display option to Off. If you were trying to select closed captioning, select CC1 instead of Text1-4.
Black bands appear at the edges of the screen 	<ul style="list-style-type: none"> • Some wide screen programs are filmed in aspect ratios that are greater than 16:9 (this is especially common with theatrical releases). Your TV will show these programs with black bands at the top and bottom of the screen. For more details, check the documentation that came with your DVD (or contact your program provider). • Programs in 4:3 aspect ratio will have bands on left and right sides of the screen. • Programs broadcasted in HD formats (720p and 1080i) with 4:3 content will commonly have black bands on the left and right sides of the screen which are added by the broadcaster (see image on left). • Auto Wide will not expand the picture when the black bands on the sides of the screen are added by the broadcaster. You can manually change the Wide Mode to Wide Zoom, H Stretch or Zoom to fill the screen, which will remain in affect until you change the channel or input or manually change the Wide Mode again.
Certain programs on DVD or other digital sources display a loss of detail, especially during fast-motion or dark scenes	<ul style="list-style-type: none"> • This is due to the digital compression of the source content used by certain digital broadcasts and DVDs which may cause your TV’s screen to display less detail than usual, or cause artifacts (small blocks or dots, pixelations) to appear on your screen. These signal compressions are more visible and are dependent on the clarity and resolution of the TV.
Remote control does not operate	<ul style="list-style-type: none"> • To determine if the problem is with the remote control or not, press a button on the TV. • Check the polarity of the batteries or replace the batteries. • Point the remote control at the remote control sensor located at the front of the TV. • Keep the remote control sensor area clear from obstacles. • Fluorescent lamps can interfere with your remote control operation; try turning off the fluorescent lamps.

(Continued)

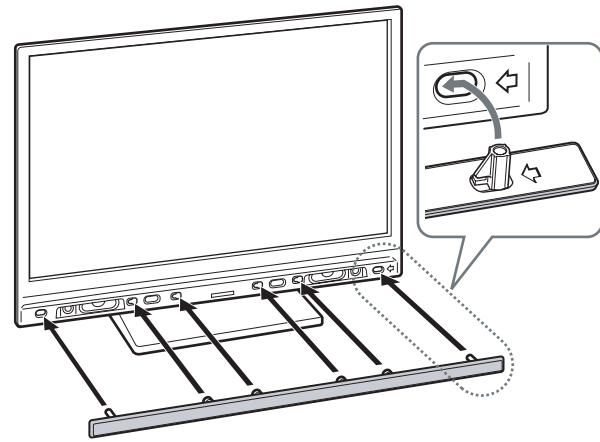
Condition	Explanation/Solution
Some digital cable channels are not being displayed	<ul style="list-style-type: none"> • Certain cable companies have limitations on the broadcast of digital cable channels. Check with your cable company for more information. • The digital cable channel may be set to Hidden in the Show/Hide Channels setting (see page 46).
Some photo files or music files are not displayed from my USB equipment or DLNA Certified media server	<ul style="list-style-type: none"> • The accessible file or folder limit in a directory is 1,000 for USB and 30,000 for a DLNA Certified media server. This limit includes non-JPEG, MP3 files or just folders. Files or folders are populated based on their time stamps. Photo, music files or folders exceeding the limit will not be displayed.
Photo images appear small in the screen	<ul style="list-style-type: none"> • Set Display Size to Expanded (see page 31). • Whether or not photo images can or cannot be displayed in full-screen depends on the resolution or aspect ratio of the file.
Photo images or folders take time to display	<ul style="list-style-type: none"> • Depending on the image dimension, file size, and number of files in a folder, some photo images or folders take time to display. • The first time a camera is connected to the TV via USB cable, it may take up to a couple of minutes for the photos to display.
Lost password	<ul style="list-style-type: none"> • Select the Password settings on the Parental Lock settings, then enter the following master password: 4357. This password clears your previous password and allows you to enter a new password (see page 47).
How to reset the TV to factory settings	<ul style="list-style-type: none"> • Turn on the TV. While holding down ▲ on the remote control, press POWER on the TV. (The TV will turn itself off, then back on again.) Release ▲. WARNING: The reset will clear all of your customized settings including the Parental Lock setting.
The speaker grill is loose	<ul style="list-style-type: none"> • Orient the speaker grill so that the location of the marks on the speaker grill and TV match, insert the protrusions on the speaker grill into the holes on the TV, and support gently. Check that the speaker grill and TV are in contact without any gaps, and then secure it by pushing and sliding the speaker grill left into place.
	
TV screen feels warm	<ul style="list-style-type: none"> • Due to the thin profile of this television, the heat generated by the LCD panel backlight and supporting electronics will be more noticeable. This is normal operation and not a cause for concern.

Specifications

Model	KDL-40XBR6	KDL-46XBR6	KDL-52XBR6
System			
Television system	NTSC: American TV standard ATSC (8VSB terrestrial): ATSC compliant 8VSB QAM on cable: ANSI/SCTE 07 2000 (Does not include CableCARD functionality)		
Channel coverage	Analog terrestrial: 2 - 69 / Digital terrestrial: 2 - 69 Analog Cable: 1 - 135 / Digital Cable: 1 - 135		
Panel system	LCD (Liquid Crystal Display) Panel		
Speaker output	8W (L) + 8W (R) + 11W (Assist Woofer)	10W (L) + 10W (R) + 15W (Assist Woofer)	
Input/Output jacks			
CABLE/ANTENNA	75-ohm external terminal for RF inputs		
VIDEO IN 1/2/3	S VIDEO (4-pin mini DIN) (VIDEO 1 only): Y: 1.0 Vp-p, 75 ohms unbalanced, sync negative / C: 0.286 Vp-p (Burst signal), 75 ohms VIDEO: 1 Vp-p, 75 ohms unbalanced, sync negative AUDIO: 500 mVrms (Typical) / Impedance: 47 kilohms		
COMPONENT IN 1/2	YPBPR (Component Video): Y: 1.0 Vp-p, 75 ohms unbalanced, sync negative / PB: 0.7 Vp-p, 75 ohms / PR: 0.7 Vp-p, 75 ohms / Signal format: 480i, 480p, 720p, 1080i, 1080p AUDIO: 500 mVrms (Typical) / Impedance: 47 kilohms		
HDMI IN 1/2/3/4	HDMI: Video: 480i, 480p, 720p, 1080i, 1080p, 1080/24p / Audio: Two channel linear PCM 32, 44.1 and 48 kHz, 16, 20 and 24bits, Dolby Digital AUDIO (HDMI IN 4 only): 500 mVrms (Typical) / Impedance: 47 kilohms		
AUDIO OUT	500 mVrms (Typical)		
DIGITAL AUDIO OUT (OPTICAL)	PCM/Dolby Digital optical signal		
PC IN	D-sub 15-pin, analog RGB, 0.7 Vp-p, 75 ohms, positive See the PC Input Signal Reference Chart on page 14.		
PC AUDIO INPUT	Stereo mini jack, 500 mVrms, (Typical) / Impedance: 47 kilohms		
LAN (10/100)	10 BASE-T/100 BASE-TX Connector (connection speed may vary depending on the network environment. This product does not guarantee network quality or speed of 10 BASE-T/100 BASE-TX terminals.)		
DMPORT	VIDEO: 1 Vp-p, 75 ohms unbalanced, sync negative AUDIO: 500 mVrms (Typical) / Impedance: 47 kilohms		
USB	Hi-Speed USB		
Power and others			
Power requirement	120 V AC, 60 Hz		
Power consumption			
in use	225 W	285 W	295 W
in standby	All models less than 0.2 W*		
Screen size (inches measured diagonally)	40	46	52
Display resolution	1,920 dots (horizontal) × 1,080 lines (vertical)		
Speaker/Front (2) (mm) (inches)	34 × 104 1 ³ / ₈ × 4 ¹ / ₈		
Tweeter (2) (mm) ø (inches) ø	30 1 ¹ / ₈		
Assist Woofer (mm) (inches)	50 × 100 2 × 4	55 × 120 2 ¹ / ₈ × 4 ³ / ₄	
Dimensions (W x H x D)			
with stand (mm) (inches)	953 x 684 x 279 37 ⁵ / ₈ x 27 x 11	1089 x 765 x 307 42 ⁷ / ₈ x 30 ¹ / ₈ x 12 ¹ / ₈	1257 x 874 x 346 49 ¹ / ₂ x 34 ¹ / ₂ x 13 ⁵ / ₈
without stand (mm) (inches)	953 x 645 x 103 37 ⁵ / ₈ x 25 ¹ / ₂ x 4 ¹ / ₈	1089 x 723 x 104 42 ⁷ / ₈ x 28 ¹ / ₂ x 4 ¹ / ₈	1257 x 831 x 127 49 ¹ / ₂ x 32 ³ / ₄ x 5
wall-mount hole pattern (mm)	300 × 300		
wall-mount screw size	M6 (length: refer to diagram on page 7)		
Mass with stand (kg) (lb.)	20.0 45.0	23.5 52.0	35.5 79.0
without stand (kg) (lb.)	23.5 52.0	28.0 62.0	42.5 94.0
Supplied accessories	Remote control RM-YD024 (1) / Size AA batteries (2) / AC power cord (1) / Cable holder (1 attached to the Table-Top Stand) / Operating Instructions (1) / Quick Setup Guide (1) / Warranty Card (1) / Safety and Regulatory Booklet (1) For KDL-40XBR6 and KDL-46XBR only: Attaching the Table-Top Stand (1) / Screws (4)		
Optional accessories	Connecting cables / Support Belt Kit / Colour Variation Unit / Wall-Mount Bracket: SU-WL500 / TV Stand: see page 2		

* While the TV is collecting TV Guide data and/or during software update the power consumption is less than 30 W.



- Optional accessories availability depends on its stock.
- Design and specifications are subject to change without notice.

Index

0-9 buttons 20
4:3 Default 45

A

AC IN 11
Add Digital Channels 46
Add for Slideshow 33
Add to Favorites 31, 33
Advanced Settings 42
Analog CC 47
Audio Out 44
AUDIO OUT jack 11
Auto Adjust 45
Auto Program 46
Auto Wide 44

B

Background TV 29
Backlight 41
Balance 43
Bass 43
BD/DVD MENU button 20
BD/DVD TOP MENU button 20
Bilingual audio 44
Brightness 41

C

CABLE/ANTENNA input 11
CC button 22
CC Display 47
CH +/- button 23
Channel Block 48
Channel Tuning Keys 50
CineMotion 42
Color 41
Color Temperature 41
COMPONENT IN jack (1080p/1080i/
720p/480p/480i) 11
Contact Sony 40
Control for HDMI 50
Country 47
Current Time 40

D

Device Auto Power Off 50
Device List 50
DIGITAL AUDIO OUT (OPTICAL)
jack 11
Digital CC 47
Digital Rating 48
Display Area 45
DISPLAY button 19
Display Options 47
DMe^x button 19
DMe^x/SERVICE 11
DVR/VCR Record Buttons 20

E

Edit Channel Labels 46
English Rating 49
ENT button 20
Equipment Control/BRAVIA Sync 19

F

F1/F2 button 23
Favorites 28
FAVORITES button 20
File Actions 31
File Order 31, 33
FREEZE button 22
French Rating 49
FUNCTION buttons 19

G

Game Mode 43
GUIDE button 20

H

H Center 45
HDMI IN jack 11
HOME button 20
Home Menu Scrolling 52
Hue 41

I

Info Banner 51
Information 31, 33
Infrared Receiver (IR) 24
INPUT button 22
Installing the TV on a wall 7

J

JUMP button 23

L

Language 51
LIGHT button 19
Light Sensor
Described 24
Setting 52
Logo Illumination 52

M

Manage Inputs 50
Motion Enhancer 42
Movie Rating 49
MPEG Noise Reduction 41
MTS 44
Music 32
MUTING button 20

N

Network Setup 51
Noise Reduction 41

O

Omit from Slideshow 33
OPTIONS button 22

P

P&P 37
Password 47
PC IN jack 11
PC Power Management 52
Phase 45
Photo 30
Photo Settings 31
PIC OFF/TIMER LED 24
Picture 41
Picture Adjustments 32, 41
Picture Adjustments Lock 52
PICTURE button 22
Picture Mode 41
PIP 37
Pitch 45
Playback Method 31, 33
POWER button 21
POWER LED 24
Power Saving 52

R

Rating 48
Remote control
programming 25
Remove from Favorites 31, 33
Reset 41, 43, 45, 56
RETURN button 20

S

S VIDEO jack 11
Screen Position 45
Server Diagnostics 51
Settings
Channel 46
Clock/Timers 40
Closed Captions (CC) 47
External Inputs 50
General Setup 51
HDMI Settings 50
Initial Setup 52
Network 51
Parental Lock 47
Picture 41
Product Support 40
Screen 44
Sound 43
Sharpness 41
Show/Hide Channels 46
Show/Hide Servers 51
Signal Diagnostics 40
Signal Type 46
Sleep Timer 40
Software Update 40
Sound Adjustments 32, 43
Sound Booster 43
SOUND button 19
Sound Mode 43
Speaker 24
Speakers 32, 44
STANDBY LED 24
Start Slideshow 31

Steady Sound 43
Surround 43

T

Thumbnail View 31, 33
Timer 40
Treble 43
Troubleshooting 53–56
TV Auto Power On 50
TV Guide On Screen 34
TV POWER button 21
TV Rating 49

U

U.S.A. Rating 49
Unrated 48
USB Auto Start 51

V

V Center 45
Vertical Size 45
VIDEO IN jack 11
Video/Photo Optimizer 43
View 31
Voice Zoom 43
VOL +/- button 20
Volume Offset 43

W

WIDE button 21
Wide Mode 44, 45
Woofers Level 44

For Your Convenience

Please contact Sony Customer Support directly if you:

- Have questions on the use of your television after reading your Operating Instructions manual and Quick Setup Guide
- Experience difficulty operating your television

For United States

<http://www.sony.com/tvsupport>

or to speak with a support representative: 1-800-222-SONY (7669)

For Canada

<http://www.sony.ca/support>

or to speak with a support representative: 1-877-899-SONY (7669)

Sony will work to resolve your questions more quickly than your retailer or place of purchase.

Please Do Not Return the Product to the Store

On-line Registration Available:

Be sure to register your TV.

United States

<http://productregistration.sony.com>

Canada

<http://www.sonystyle.ca/registration>



Body pages printed on recycled paper.

<http://www.sony.net/>

Printed in U.S.A.



4 11 376 0111